

MICRO-COMPUTER BASED  
DIGITAL INDICATING CONTROLLER  
**JCL-33A**  
INSTRUCTION MANUAL

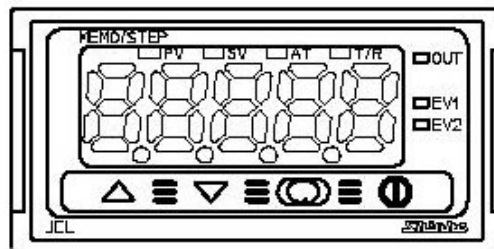

**Shinko**

# Preface

Thank you for purchasing our Micro-Computer Based Digital Indicating Controller JCL-33A. This manual contains instructions for the mounting, functions, operations and notes when operating the JCL-33A. To prevent accidents arising from the misuse of this controller, please ensure the operator receives this manual.

## Characters used in this manual

Number, °C/°F	-1	0	1	2	3	4	5	6	7	8	9	°C	°F
Indication	-1	0	1	2	3	4	5	6	7	8	9	℃	℉
Alphabet	A	B	C	D	E	F	G	H	I	J	K	L	M
Indication	A	b	c	d	E	F	G	H	I	J	k	L	m
Alphabet	N	O	P	Q	R	S	T	U	V	W	X	Y	Z
Indication	n	o	P	q	r	s	T	u	v	w	x	y	z

## Notes

- This instrument should be used in accordance with the specifications described in the manual. If it is not used according to the specifications, it may malfunction or cause a fire.
- Be sure to follow the warnings, cautions and notices. If they are not observed, serious injury or malfunction may occur.
- The contents of this instruction manual are subject to change without notice.
- Care has been taken to ensure that the contents of this instruction manual are correct, but if there are any doubts, mistakes or questions, please inform our sales department.
- Measures must be taken to ensure that the operator cannot touch power terminals or other high voltage sections.
- Any unauthorized transfer or copying of this document, in part or in whole, is prohibited.
- Shinko Technos Co., Ltd. is not liable for any damage or secondary damage(s) incurred as a result of using this product, including any indirect damage.

# Safety Precautions

**(Be sure to read these precautions before using our products.)**

The safety precautions are classified into categories: "Warning" and "Caution".

Depending on circumstances, procedures indicated by ⚠ Caution may result in serious consequences, so be sure to follow the directions for usage.

## **Warning**

Procedures which may lead to dangerous conditions and cause death or serious injury, if not carried out properly.

## **Caution**

Procedures which may lead to dangerous conditions and cause superficial to medium injury or physical damage or may degrade or damage the product, if not carried out properly.

## **SAFETY PRECAUTIONS**

- To ensure safe and correct use, thoroughly read and understand this manual before using this instrument.
- This instrument is intended to be used for industrial machinery, machine tools and measuring equipment. Verify correct usage after purpose-of-use consultation with our agency or main office. (Never use this instrument for medical purposes with which human lives are involved.)
- External protection devices such as protective equipment against excessive temperature rise, etc. must be installed, as malfunction of this product could result in serious damage to the system or injury to personnel. Proper periodic maintenance is also required.
- This instrument must be used under the conditions and environment described in this manual. Shinko Technos Co., Ltd. does not accept liability for any injury, loss of life or damage occurring due to the instrument being used under conditions not otherwise stated in this manual.

### Caution with respect to Export Trade Control Ordinance

To avoid this instrument from being used as a component in, or as being utilized in the manufacture of weapons of mass destruction (i.e. military applications, military equipment, etc.), please investigate the end users and the final use of this instrument.

In the case of resale, ensure that this instrument is not illegally exported.

## 1. Installation Precautions

### Caution

This instrument is intended to be used under the following environmental conditions (IEC61010-1):

Overvoltage category II, Pollution degree 2

Ensure the mounting location corresponds to the following conditions:

- A minimum of dust, and an absence of corrosive gases
- No flammable, explosive gases
- No mechanical vibrations or shocks
- No exposure to direct sunlight, an ambient temperature of 0 to 50°C (32 to 122°F) that does not change rapidly, and no icing
- An ambient non-condensing humidity of 35 to 85 %RH
- No large capacity electromagnetic switches or cables through which large current is flowing
- No water, oil or chemicals or the vapors of these substances can come into direct contact with the unit
- Please note that the ambient temperature of this unit – not the ambient temperature of the control panel – must not exceed 50°C (122°F) if mounted through the face of a control panel, otherwise the life of electronic components (especially electrolytic capacitors) may be shortened.

Note: Avoid setting this instrument directly on or near flammable material even though the case of this instrument is made of flame-resistant resin.

## 2. Wiring Precautions

### Caution

- Do not leave wire remnants in the instrument, as they could cause a fire or malfunction.
- Use the solderless terminal with an insulation sleeve in which the M3 screw fits when wiring the instrument.
- Tighten the terminal screw using the specified torque. If excessive force is applied to the screw when tightening, the terminal screw or case may be damaged.
- This controller does not have a built-in power switch, circuit breaker and fuse. It is necessary to install a power switch, circuit breaker and fuse near the controller.  
(Recommended fuse: Time-lag fuse, rated voltage 250 V AC, rated current 2 A)
- For a 24 V AC/DC power source, do not confuse polarity when using direct current (DC).
- Do not apply a commercial power source to the sensor which is connected to the input terminal nor allow the power source to come into contact with the sensor.
- Use a thermocouple and compensating lead wire according to the sensor input specifications of this controller.
- Use the 3-wire RTD according to the sensor input specifications of this controller.
- When using a relay contact output type, externally use a relay according to the capacity of the load to protect the built-in relay contact.
- When wiring, keep input wires (thermocouple, RTD, etc.) away from controller AC power sources or load wires.

## 3. Operation and Maintenance Precautions

### Caution

- It is recommended that the AT be performed on the trial run.
- Do not touch live terminals. This may cause electric shock or problems in operation.
- Turn the power supply to the instrument OFF before retightening the terminal or cleaning.  
Working on or touching the terminal with the power switched ON may result in severe injury or death due to electrical shock.
- Use a soft, dry cloth when cleaning the instrument.  
(Alcohol based substances may tarnish or deface the unit.)
- As the display section is vulnerable, be careful not to put pressure on, scratch or strike it with a hard object.

# --- CONTENTS ---

	Page
<b>1. Model</b>	
1.1 Model -----	5
1.2 How to Read the Model Label -----	5
<b>2. Name and Functions of Controller</b> -----	5
<b>3. Mounting to the Control Panel</b>	
3.1 Site Selection -----	6
3.2 External Dimensions -----	6
3.3 Panel Cutout -----	6
3.4 Mounting -----	6
<b>4. Wiring</b> -----	7
<b>5. Setup</b> -----	8
5.1 Auxiliary Function Setting Mode 2 -----	9
<b>6. Settings</b>	
6.1 Main Setting Mode -----	14
6.2 Sub Setting Mode -----	16
6.3 Auxiliary Function Setting Mode 1 -----	17
<b>7. Operation</b>	
7.1 Starting Operation -----	18
7.2 MV (Output Manipulated Variable) Indication -----	19
7.3 Control Output OFF Function -----	19
7.4 AT Perform/Cancel -----	19
<b>8. Key Operation Flowchart</b> -----	20
<b>9. AT (Auto-Tuning)</b> -----	22
<b>10. Action Explanation</b>	
10.1 OUT1 Action -----	23
10.2 OUT1 ON/OFF Control Action -----	23
10.3 A1, A2 Action -----	24
10.4 OUT2 (Heating/Cooling Control) Action (When DR Option is Applied) -	24
10.5 OUT2 (Heating/Cooling Control) Action (When Setting Dead Band)	
(When DR Option is Added) -----	25
10.6 OUT2 (Heating/Cooling Control) Action (When Setting Overlap Band)	
(When DR Option is Applied) -----	25
10.7 Timer Action -----	25
<b>11. Specifications</b>	
11.1 Standard Specifications -----	26
11.2 Optional Specifications -----	28
<b>12. Troubleshooting</b>	
12.1 Indication -----	29
12.2 Key Operation -----	30
12.3 Control -----	31
<b>13. Character Table</b> -----	31

# 1. Model

## 1.1 Model

JCL-33 A -□/□ □ □ □ □		Series name: JCL-33A (W48 x H24 x D109mm)	
A1	A	Alarm type can be selected by keypad. (*1)	
OUT1	R	Relay contact: 1a	
	S	Non-contact voltage (for SSR drive): 12 <sup>+2</sup> <sub>0</sub> V DC	
	A	Direct current: 4 to 20 mA DC	
Input	M	Multi-range (*2)	
Supply voltage		100 to 240 V AC (Standard)	
		1	24 V AC/DC (*3)
Option		DR	Heating/Cooling control output OUT2 (Relay contact output)
		C5	Serial communication (RS-485)
		BK	Color: Black
		TC	Terminal cover

\*1: Alarm types (9 types and No alarm action), Timer function and Pattern end output can be selected by keypad.

\*2: Thermocouple, RTD, Direct current and DC voltage can be selected by keypad.

For Direct current input, a 50 Ω shunt resistor (sold separately) must be connected between input terminals.

\*3: For the power supply voltage, 100 to 240 V AC is standard.

However, when ordering 24 V AC/DC, enter "1" after the input code.

## 1.2 How to Read the Model Label

Model labels are attached to the case and the inner assembly.

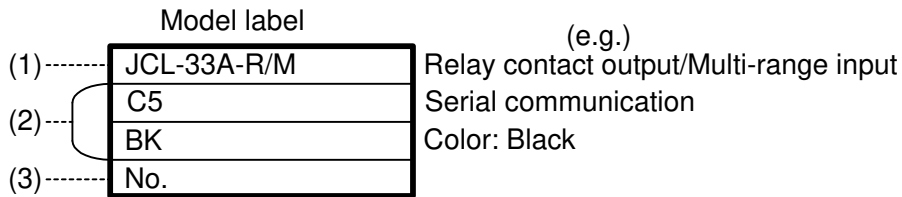

(1): Model

(2): Option, power supply voltage ("1" is entered only for 24 V AC/DC)

(3): Serial number

# 2. Name and Functions of Controller

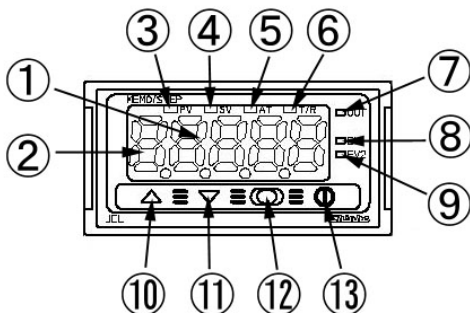

① **PV/SV Display (red)**: Indicates the PV (process variable) and SV (desired value). During setting mode, characters and set value of the setting item are indicated alternately.

② **MEMO/STEP Display (green)**: Indicates memory number during fixed value control. Indicates step number during program control.

③ **PV indicator (red)**: Lights when PV (process variable) is indicated.

④ **SV indicator (green)**: Lights when SV (desired value) is indicated.

⑤ **AT indicator (yellow)**: Flashes during AT (auto-tuning).

⑥ **T/R indicator (yellow)**: Flashes during serial communication.

(Lit while sending data. Unlit while receiving data)

⑦ **OUT indicator (green)**: Lights when OUT1 is ON.

[For Direct current output type, flashes corresponding to the MV (manipulated variable) in 250 ms cycles.]

⑧ **EV1 indicator (red)**: Lights when Event output 1 or OUT2 (DR option) is ON.

⑨ **EV2 indicator (red)**: Lights when Event output 2 is ON.

⑩ **UP key (△)**: Increases the numerical value.

⑪ **DOWN key (▽)**: Decreases the numerical value.

- ⑫ **MODE key** (⏻): Selects the setting mode or registers the set value.  
By pressing the MODE key, the set (or selected) value can be registered.
- ⑬ **OUT/OFF key** (⏻): The Control output ON/OFF or Program control RUN/STOP can be switched.

### 3. Mounting to the Control Panel

#### 3.1 Site Selection

**This instrument is intended to be used under the following environmental conditions (IEC61010-1): Overvoltage category II, Pollution degree 2**

Ensure the mounting location corresponds to the following conditions:

- A minimum of dust, and an absence of corrosive gases
- No flammable, explosive gases
- No mechanical vibrations or shocks
- No exposure to direct sunlight, an ambient temperature of 0 to 50°C (32 to 122°F) that does not change rapidly, and no icing
- An ambient non-condensing humidity of 35 to 85%RH
- No large capacity electromagnetic switches or cables through which large current is flowing
- No water, oil or chemicals or the vapors of these substances can come into direct contact with the controller
- Please note that the ambient temperature of this unit – not the ambient temperature of the control panel – must not exceed 50°C (122°F) if mounted through the face of a control panel, otherwise the life of electronic parts (especially electrolytic capacitors) may be shortened.

#### 3.2 External Dimensions (Scale: mm)

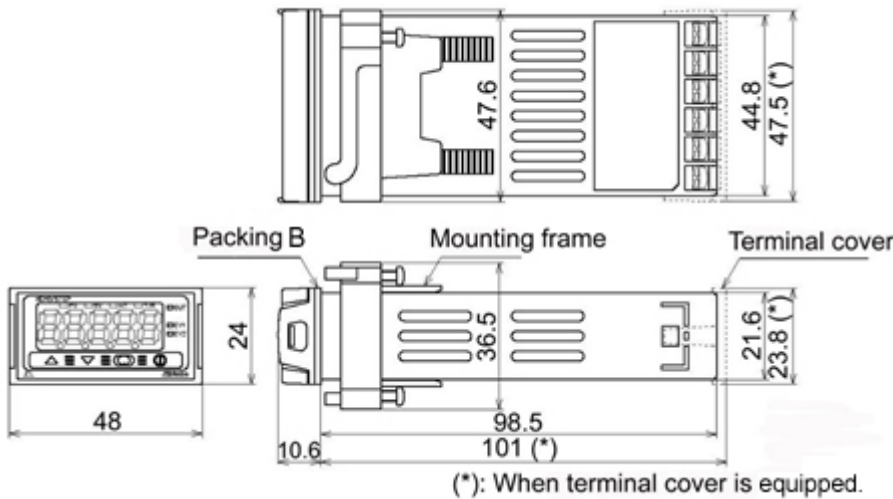

(Fig. 3.2-1)

#### 3.3 Panel Cutout (Scale: mm)

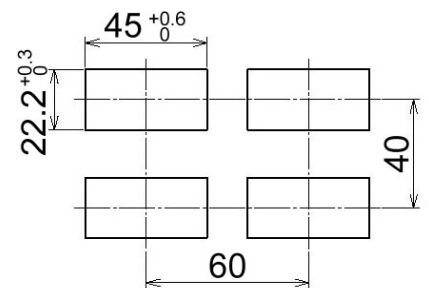

(Fig. 3.3-1)

#### 3.4 Mounting

Mount the controller vertically to the flat, rigid panel to ensure it adheres to the Drip-proof/Dust-proof specification (IP66).

Mountable panel thickness: 1 to 10 mm

(1) Insert the controller from the front side of the panel. (Fig. 3.4-1)

(2) Insert the mounting frame until 2 tips of the frame touch the panel. (Fig. 3.4-2)

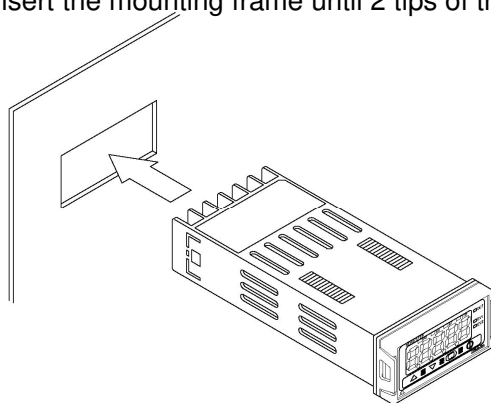

(Fig.3.4-1)

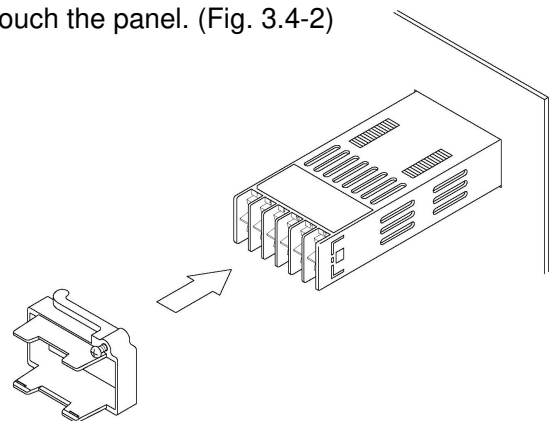

(Fig.3.4-2)

# 4. Wiring



## Warning

Turn the power supply to the instrument off before wiring.

Working on or touching the terminal with the power switched on may result in severe injury or death due to electrical shock.



## Caution

- Use a thermocouple and compensating lead wire corresponding to the sensor input specification of this controller.
- Use the 3-wire RTD corresponding to the input specification of this controller.
- This controller does not have built-in power switch, circuit breaker and fuse. Therefore, it is necessary to install a power switch, circuit breaker and fuse near the controller.  
(Recommended fuse: Time-lag fuse, rated voltage 250 V AC, rated current 2 A)
- For a 24 V AC/DC power source, do not confuse polarity when using direct current (DC).
- When using a relay contact output type, externally use a relay according to the capacity of the load to protect the built-in relay contact.
- When wiring, keep input wires (thermocouple, RTD, etc.) away from the AC sources or load wires.
- Do not apply a commercial power source to the sensor connected to the input terminal nor allow the power source to come into contact with the sensor.

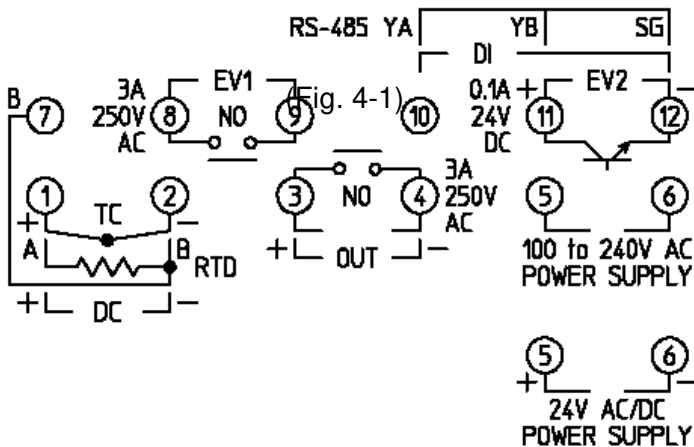

- TC: Thermocouple input terminals
- RTD: RTD input terminals
- DC: Direct current, DC voltage input terminals  
**For direct current input type, connect a 50 Ω shunt resistor (sold separately) between input terminals.**
- OUT: OUT1 output terminals
- POWER SUPPLY: Power terminals
- EV1: Event output 1 or OUT2 (when DR option is equipped)] terminals
- EV2: Event output 2 terminals
- DI: DI input terminals  
Three DI input functions: SV1/SV2 external selection, ON/OFF (RUN/STOP) external selection, Timer function
- RS-485: Serial communication (C5) terminals  
(Only when C5 option is equipped)

### Lead wire solderless terminal

Use a solderless terminal with an insulation sleeve in which the M3 screw fits as shown below. The torque is 0.63 N•m.

Solderless terminal	Manufacturer	Model	Tightening torque
Y-type	Nichifu Terminal Industries CO., LTD.	TMEV1.25Y-3	0.63 N•m
	Japan Solderless Terminal MFG CO., LTD.	VD1.25-B3A	
Ring-type	Nichifu Terminal Industries CO., LTD.	TMEV1.25-3	
	Japan Solderless Terminal MFG CO., LTD.	V1.25-3	

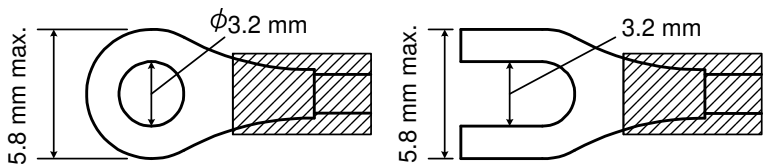

(Fig. 4-2)

# 5. Setup

Setup (setting the Input type, Alarm type, Control action, etc.) should be done before using this controller, according to the user's conditions.

Factory default values are set as follows.

Input: K -200 to 1370°C, Alarm 1 (A1): No alarm action, Alarm 2 (A2): No alarm action, Reverse (Heating) action

If the user's specification is the same as the factory default value of this instrument, or if user's instrument has already been installed in a system, it is not necessary to set up the controller. Proceed to Section "6.1 Main Setting Mode".

## Turn the power supply to the instrument on.

For approx. 3 seconds after the power is turned on, the MEMO/STEP Display is turned off, and the PV/SV Display indicates sensor input characters and temperature unit. (Table 5-1) During this time, all outputs and LED indicators are in OFF status.

(Table 5-1)



Sensor input	PV/SV Display	
	°C	°F
K	ℓ ℓ ℓ ℓ	ℓ ℓ ℓ ℓ
J	ℓ ℓ ℓ ℓ	ℓ ℓ ℓ ℓ
R	ℓ ℓ ℓ ℓ	ℓ ℓ ℓ ℓ
S	ℓ ℓ ℓ ℓ	ℓ ℓ ℓ ℓ
B	ℓ ℓ ℓ ℓ	ℓ ℓ ℓ ℓ
E	ℓ ℓ ℓ ℓ	ℓ ℓ ℓ ℓ
T	ℓ ℓ ℓ ℓ	ℓ ℓ ℓ ℓ
N	ℓ ℓ ℓ ℓ	ℓ ℓ ℓ ℓ
PL-II	ℓ ℓ ℓ ℓ	ℓ ℓ ℓ ℓ
C (W/Re5-26)	ℓ ℓ ℓ ℓ	ℓ ℓ ℓ ℓ
Pt100	ℓ ℓ ℓ ℓ	ℓ ℓ ℓ ℓ
JPt100	ℓ ℓ ℓ ℓ	ℓ ℓ ℓ ℓ
4 to 20 mA DC	420A	
0 to 20 mA DC	020A	
0 to 1 V DC	00.1A	
0 to 5 V DC	00.5A	
1 to 5 V DC	0.5A	
0 to 10 V DC	0.10A	

After that, the following is indicated.

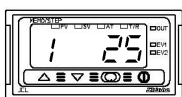

The MEMO/STEP Display indicates a memory number.  
The PV/SV Display indicates an input value (PV) (e.g. room temperature).  
This is PV/SV Display mode.

## Basic operation for setup

Setup is conducted in Auxiliary function setting mode 2.  
To enter Auxiliary function setting mode 2, press the  $\Delta$  and  $\nabla$  keys (in that order) together for approx. 3 seconds in PV/SV Display mode.  
Use the  $\Delta$  or  $\nabla$  key for settings (or selections).  
To register the set data, use the  $\odot$  key.

## Display used for explaining setting items

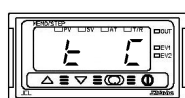
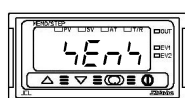

Setting items (Section "5 Setup", and setting modes from Sections 6.1 to 6.3) are explained as follows.  
(e.g.) Input type



$\longleftrightarrow$  means that input characters 4En4 and selected input type ℓ ℓ ℓ ℓ (K, -200 to 1370°C) are indicated alternately.

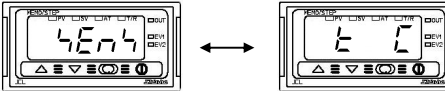

### 5.1 Auxiliary Function Setting Mode 2

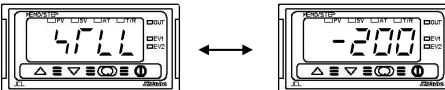
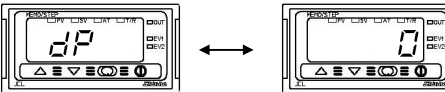
Display	Item, Function, Setting range	Factory Default																																	
	<b>Input type</b> <ul style="list-style-type: none"> <li>The input type can be selected from thermocouple (10 types), RTD (2 types), Direct current (2 types) and DC voltage (4 types). The unit °C/°F can be selected as well.</li> <li><b>When changing the input from DC voltage to other inputs, remove the sensor connected to the controller first, then change the input. If the input is changed with the sensor connected, the input circuit may break.</b></li> </ul>	K (-200 to 1370°C)																																	
	<table border="0"> <tr><td><i>E</i>□□□:</td><td>K</td><td>-200 to 1370 °C</td></tr> <tr><td><i>E</i>□□:</td><td></td><td>-199.9 to 400.0°C</td></tr> <tr><td><i>J</i>□□□:</td><td>J</td><td>-200 to 1000 °C</td></tr> <tr><td><i>r</i>□□□:</td><td>R</td><td>0 to 1760 °C</td></tr> <tr><td><i>4</i>□□□:</td><td>S</td><td>0 to 1760 °C</td></tr> <tr><td><i>b</i>□□□:</td><td>B</td><td>0 to 1820 °C</td></tr> <tr><td><i>E</i>□□□:</td><td>E</td><td>-200 to 800 °C</td></tr> <tr><td><i>r</i>□□□:</td><td>T</td><td>-199.9 to 400.0°C</td></tr> <tr><td><i>n</i>□□□:</td><td>N</td><td>-200 to 1300 °C</td></tr> <tr><td><i>PL2</i>□:</td><td>PL-II</td><td>0 to 1390 °C</td></tr> <tr><td><i>c</i>□□□:</td><td>C (W/Re5-26)</td><td>0 to 2315 °C</td></tr> </table>	<i>E</i> □□□:	K	-200 to 1370 °C	<i>E</i> □□:		-199.9 to 400.0°C	<i>J</i> □□□:	J	-200 to 1000 °C	<i>r</i> □□□:	R	0 to 1760 °C	<i>4</i> □□□:	S	0 to 1760 °C	<i>b</i> □□□:	B	0 to 1820 °C	<i>E</i> □□□:	E	-200 to 800 °C	<i>r</i> □□□:	T	-199.9 to 400.0°C	<i>n</i> □□□:	N	-200 to 1300 °C	<i>PL2</i> □:	PL-II	0 to 1390 °C	<i>c</i> □□□:	C (W/Re5-26)	0 to 2315 °C	
<i>E</i> □□□:	K	-200 to 1370 °C																																	
<i>E</i> □□:		-199.9 to 400.0°C																																	
<i>J</i> □□□:	J	-200 to 1000 °C																																	
<i>r</i> □□□:	R	0 to 1760 °C																																	
<i>4</i> □□□:	S	0 to 1760 °C																																	
<i>b</i> □□□:	B	0 to 1820 °C																																	
<i>E</i> □□□:	E	-200 to 800 °C																																	
<i>r</i> □□□:	T	-199.9 to 400.0°C																																	
<i>n</i> □□□:	N	-200 to 1300 °C																																	
<i>PL2</i> □:	PL-II	0 to 1390 °C																																	
<i>c</i> □□□:	C (W/Re5-26)	0 to 2315 °C																																	
	<table border="0"> <tr><td><i>PT</i>□:</td><td>Pt100</td><td>-199.9 to 850.0°C</td></tr> <tr><td><i>JPT</i>□:</td><td>JPt100</td><td>-199.9 to 500.0°C</td></tr> <tr><td><i>PT</i>□□:</td><td>Pt100</td><td>-200 to 850 °C</td></tr> <tr><td><i>JPT</i>□□:</td><td>JPt100</td><td>-200 to 500 °C</td></tr> </table>	<i>PT</i> □:	Pt100	-199.9 to 850.0°C	<i>JPT</i> □:	JPt100	-199.9 to 500.0°C	<i>PT</i> □□:	Pt100	-200 to 850 °C	<i>JPT</i> □□:	JPt100	-200 to 500 °C																						
<i>PT</i> □:	Pt100	-199.9 to 850.0°C																																	
<i>JPT</i> □:	JPt100	-199.9 to 500.0°C																																	
<i>PT</i> □□:	Pt100	-200 to 850 °C																																	
<i>JPT</i> □□:	JPt100	-200 to 500 °C																																	
	<table border="0"> <tr><td><i>E</i>□□F:</td><td>K</td><td>-320 to 2500 °F</td></tr> <tr><td><i>E</i>□□:</td><td></td><td>-199.9 to 750.0°F</td></tr> <tr><td><i>J</i>□□□:</td><td>J</td><td>-320 to 1800 °F</td></tr> <tr><td><i>r</i>□□□:</td><td>R</td><td>0 to 3200 °F</td></tr> <tr><td><i>4</i>□□□:</td><td>S</td><td>0 to 3200 °F</td></tr> <tr><td><i>b</i>□□□:</td><td>B</td><td>0 to 3300 °F</td></tr> <tr><td><i>E</i>□□□:</td><td>E</td><td>-320 to 1500 °F</td></tr> <tr><td><i>r</i>□□□:</td><td>T</td><td>-199.9 to 750.0°F</td></tr> <tr><td><i>n</i>□□□:</td><td>N</td><td>-320 to 2300 °F</td></tr> <tr><td><i>PL2</i>F:</td><td>PL-II</td><td>0 to 2500 °F</td></tr> <tr><td><i>c</i>□□□:</td><td>C (W/Re5-26)</td><td>0 to 4200 °F</td></tr> </table>	<i>E</i> □□F:	K	-320 to 2500 °F	<i>E</i> □□:		-199.9 to 750.0°F	<i>J</i> □□□:	J	-320 to 1800 °F	<i>r</i> □□□:	R	0 to 3200 °F	<i>4</i> □□□:	S	0 to 3200 °F	<i>b</i> □□□:	B	0 to 3300 °F	<i>E</i> □□□:	E	-320 to 1500 °F	<i>r</i> □□□:	T	-199.9 to 750.0°F	<i>n</i> □□□:	N	-320 to 2300 °F	<i>PL2</i> F:	PL-II	0 to 2500 °F	<i>c</i> □□□:	C (W/Re5-26)	0 to 4200 °F	
<i>E</i> □□F:	K	-320 to 2500 °F																																	
<i>E</i> □□:		-199.9 to 750.0°F																																	
<i>J</i> □□□:	J	-320 to 1800 °F																																	
<i>r</i> □□□:	R	0 to 3200 °F																																	
<i>4</i> □□□:	S	0 to 3200 °F																																	
<i>b</i> □□□:	B	0 to 3300 °F																																	
<i>E</i> □□□:	E	-320 to 1500 °F																																	
<i>r</i> □□□:	T	-199.9 to 750.0°F																																	
<i>n</i> □□□:	N	-320 to 2300 °F																																	
<i>PL2</i> F:	PL-II	0 to 2500 °F																																	
<i>c</i> □□□:	C (W/Re5-26)	0 to 4200 °F																																	
	<table border="0"> <tr><td><i>PT</i>□F:</td><td>Pt100</td><td>-199.9 to 999.9°F</td></tr> <tr><td><i>JPT</i>□F:</td><td>JPt100</td><td>-199.9 to 900.0°F</td></tr> <tr><td><i>PT</i>□□F:</td><td>Pt100</td><td>-300 to 1500 °F</td></tr> <tr><td><i>JPT</i>□□F:</td><td>JPt100</td><td>-300 to 900 °F</td></tr> </table>	<i>PT</i> □F:	Pt100	-199.9 to 999.9°F	<i>JPT</i> □F:	JPt100	-199.9 to 900.0°F	<i>PT</i> □□F:	Pt100	-300 to 1500 °F	<i>JPT</i> □□F:	JPt100	-300 to 900 °F																						
<i>PT</i> □F:	Pt100	-199.9 to 999.9°F																																	
<i>JPT</i> □F:	JPt100	-199.9 to 900.0°F																																	
<i>PT</i> □□F:	Pt100	-300 to 1500 °F																																	
<i>JPT</i> □□F:	JPt100	-300 to 900 °F																																	
	<table border="0"> <tr><td><i>420</i>A:</td><td>4 to 20 mA DC</td><td>-1999 to 9999</td></tr> <tr><td><i>020</i>A:</td><td>0 to 20 mA DC</td><td>-1999 to 9999</td></tr> <tr><td><i>001</i>V:</td><td>0 to 1 V DC</td><td>-1999 to 9999</td></tr> <tr><td><i>005</i>V:</td><td>0 to 5 V DC</td><td>-1999 to 9999</td></tr> <tr><td><i>105</i>V:</td><td>1 to 5 V DC</td><td>-1999 to 9999</td></tr> <tr><td><i>010</i>V:</td><td>0 to 10 V DC</td><td>-1999 to 9999</td></tr> </table>	<i>420</i> A:	4 to 20 mA DC	-1999 to 9999	<i>020</i> A:	0 to 20 mA DC	-1999 to 9999	<i>001</i> V:	0 to 1 V DC	-1999 to 9999	<i>005</i> V:	0 to 5 V DC	-1999 to 9999	<i>105</i> V:	1 to 5 V DC	-1999 to 9999	<i>010</i> V:	0 to 10 V DC	-1999 to 9999																
<i>420</i> A:	4 to 20 mA DC	-1999 to 9999																																	
<i>020</i> A:	0 to 20 mA DC	-1999 to 9999																																	
<i>001</i> V:	0 to 1 V DC	-1999 to 9999																																	
<i>005</i> V:	0 to 5 V DC	-1999 to 9999																																	
<i>105</i> V:	1 to 5 V DC	-1999 to 9999																																	
<i>010</i> V:	0 to 10 V DC	-1999 to 9999																																	
	<b>Scaling high limit</b> <ul style="list-style-type: none"> <li>Sets the scaling high limit value.</li> <li>Setting range: Scaling low limit value to input range high limit value</li> </ul>	1370°C																																	
	<b>Scaling low limit</b> <ul style="list-style-type: none"> <li>Sets the scaling low limit value.</li> <li>Setting range: Input range low limit value to scaling high limit value</li> </ul>	-200°C																																	
	<b>Decimal point place</b> <ul style="list-style-type: none"> <li>Selects decimal point place.</li> <li>Available only for DC input</li> <li>□□□□: No decimal point</li> <li>□□□: 1 digit after decimal point</li> <li>□□□□: 2 digits after decimal point</li> <li>□□□□□: 3 digits after decimal point</li> </ul>	No decimal point																																	

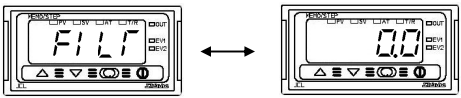
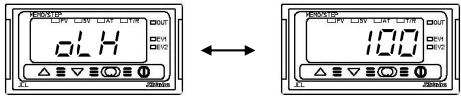
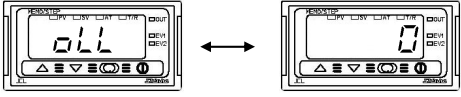
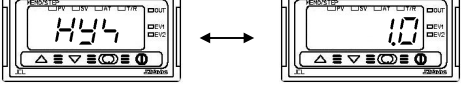
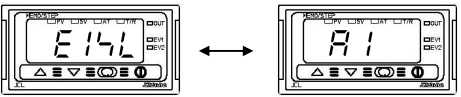
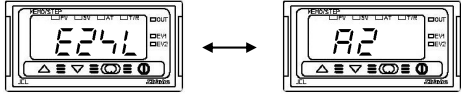
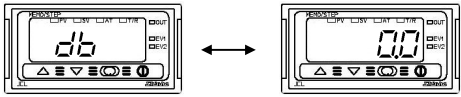
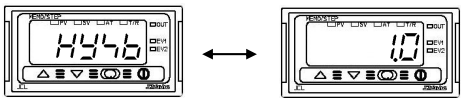
Display	Item, Function, Setting range	Factory Default
	<b>PV filter time constant</b> <ul style="list-style-type: none"> <li>Sets PV filter time constant. Input fluctuation due to noise can be reduced.</li> <li><b>If the value is set too high, it affects control results due to the delay of response.</b></li> <li>Setting range: 0.0 to 10.0 seconds</li> </ul>	0.0 seconds
	<b>OUT1 high limit</b> <ul style="list-style-type: none"> <li>Sets OUT1 high limit value.</li> <li>Not available if OUT1 is in ON/OFF control</li> <li>Setting range: OUT1 low limit value to 100% (Direct current output type: OUT1 low limit value to 105%)</li> </ul>	100%
	<b>OUT1 low limit</b> <ul style="list-style-type: none"> <li>Sets OUT1 low limit value.</li> <li>Not available if OUT1 is in ON/OFF control</li> <li>Setting range: 0% to OUT1 high limit value (Direct current output type: -5% to OUT1 high limit value)</li> </ul>	0%
	<b>OUT1 ON/OFF hysteresis</b> <ul style="list-style-type: none"> <li>Sets ON/OFF action hysteresis for OUT1.</li> <li>Available only when OUT1 is in ON/OFF control</li> <li>Setting range: 0.1 to 100.0°C (°F), or 1 to 1000 (for DC input)</li> </ul>	1.0°C
	<b>EV1 output</b> <ul style="list-style-type: none"> <li>Selects a function for EV1 output terminals.</li> <li>Not available if DR option is equipped, since EV1 terminals are used for OUT2 output terminals.</li> <li>A 1: A1 output A 2: A2 output a r: Common to A1 and A2 output</li> </ul>	A1 output
	<b>EV2 output</b> <ul style="list-style-type: none"> <li>Selects a function for EV2 output terminals.</li> <li>Not available if C5 option is equipped</li> <li>A 1: A1 output A 2: A2 output a r: Common to A1 and A2 output</li> </ul>	A2 output
	<b>Overlap band/Dead band</b> <ul style="list-style-type: none"> <li>Sets the overlap band or dead band for OUT1 and OUT2. + Set value: Dead band, - Set value: Overlap band</li> <li>Available only when the DR option is equipped</li> <li>Setting range: -100.0 to 100.0°C (°F), or -1000 to 1000 (for DC input)</li> </ul>	0.0°C
	<b>OUT2 ON/OFF hysteresis</b> <ul style="list-style-type: none"> <li>Sets ON/OFF action hysteresis for OUT2.</li> <li>Available only when the DR option is equipped, and when OUT2 is in ON/OFF control</li> <li>Setting range: 0.1 to 100.0°C (°F), or 1 to 1000 (for DC input)</li> </ul>	1.0°C

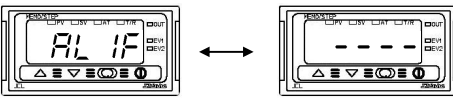
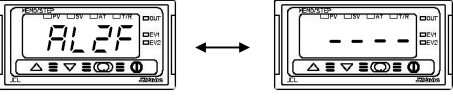
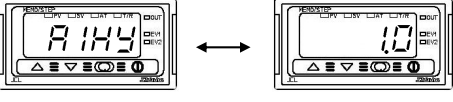
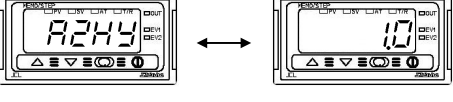
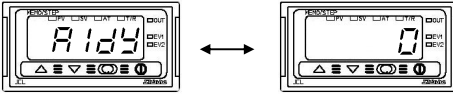
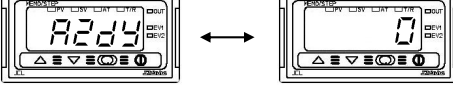
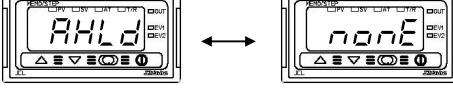
Display	Item, Function, Setting range	Factory Default
	<p><b>A1 type</b></p> <ul style="list-style-type: none"> <li>• Selects an Alarm 1 (A1) type. (See “10.3 A1, A2 Action” on p.24.)</li> <li>• ----: No alarm action</li> <li>• H---: High limit alarm</li> <li>• L---: Low limit alarm</li> <li>• HL--: High/Low limits alarm</li> <li>• d---: High/Low limit range alarm</li> <li>• R4--: Process high alarm</li> <li>• -R4-: Process low alarm</li> <li>• H---: High limit with standby alarm</li> <li>• L---: Low limit with standby alarm</li> <li>• HL--: High/Low limits with standby alarm</li> <li>• T---: Timer function</li> <li>• PEnd: Pattern end output</li> </ul> <p>• If an alarm type is changed, the alarm value becomes 0 (0.0). Therefore, it is necessary to set it again.</p> <p>• If Timer function is selected, the Timer function works only when Delay action type, Timer delay time and DI input function are set (or selected).</p>	<p>No alarm action</p>
	<p><b>A2 type</b></p> <ul style="list-style-type: none"> <li>• Selects an Alarm 2 (A2) type. (See “10.3 A1, A2 Action” on p.24.)</li> <li>• Alarm types are the same as those of A1 type.</li> </ul> <p>• If an alarm type is changed, the alarm value becomes 0 (0.0). Therefore, it is necessary to set it again.</p>	<p>No alarm action</p>
	<p><b>A1 hysteresis</b></p> <ul style="list-style-type: none"> <li>• Sets A1 hysteresis.</li> <li>• Not available if No alarm action, Timer function or Pattern end output is selected in [A1 type]</li> <li>• Setting range: 0.1 to 100.0°C(F), or 1 to 1000 (for DC input)</li> </ul>	<p>1.0°C</p>
	<p><b>A2 hysteresis</b></p> <ul style="list-style-type: none"> <li>• Sets A2 hysteresis.</li> <li>• Not available if No alarm action, Timer function or Pattern end output is selected in [A2 type]</li> <li>• Setting range: 0.1 to 100.0°C(F), or 1 to 1000 (for DC input)</li> </ul>	<p>1.0°C</p>
	<p><b>A1 delay time</b></p> <ul style="list-style-type: none"> <li>• Sets A1 action delay time.</li> <li>• When setting time has elapsed after the input enters the alarm output range, the alarm is activated.</li> <li>• Not available if No alarm action, Timer function or Pattern end output is selected in [A1 type]</li> <li>• Setting range: 0 to 9999 seconds</li> </ul>	<p>0 seconds</p>
	<p><b>A2 delay time</b></p> <ul style="list-style-type: none"> <li>• Sets A2 action delay time.</li> <li>• When setting time has elapsed after the input enters the alarm output range, the alarm is activated.</li> <li>• Not available if No alarm action, Timer function or Pattern end output is selected in [A2 type]</li> <li>• Setting range: 0 to 9999 seconds</li> </ul>	<p>0 seconds</p>
	<p><b>Alarm HOLD function</b></p> <ul style="list-style-type: none"> <li>• Enables/Disables the Alarm HOLD function for A1 or A2.</li> <li>• This setting item is common to A1 and A2.</li> <li>• Not available if No alarm action, Timer function or Pattern end output is selected in [A1 type] or [A2 type].</li> <li>• none: Alarm Not Holding</li> <li>• Hold: Alarm Holding</li> </ul>	<p>Alarm Not holding</p>

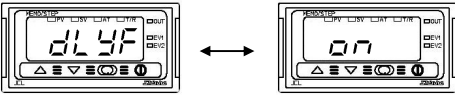
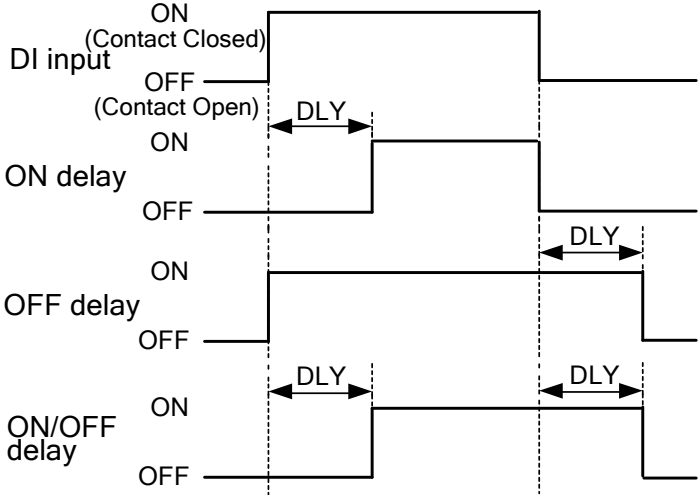
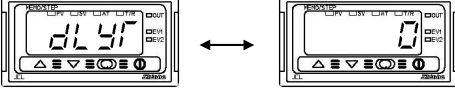
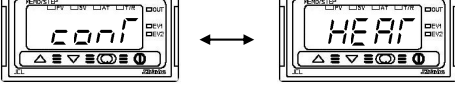
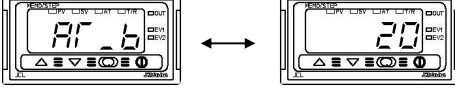
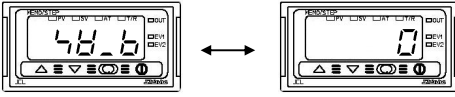
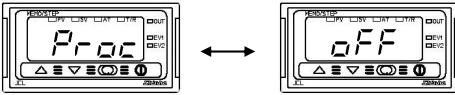
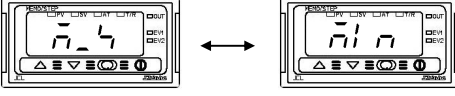
Display	Item, Function, Setting range	Factory Default
	<p><b>Delay action type</b></p> <ul style="list-style-type: none"> <li>• Selects a delay action type for the Timer function.</li> <li>• Available only when Timer function is selected in [A1 type] or [A2 type].</li> <li>• <i>on</i>: ON delay</li> <li>• <i>oFF</i>: OFF delay</li> <li>• <i>oNoF</i>: ON/OFF delay</li> </ul>  <p style="text-align: center;">DLY: Timer delay time</p> <p style="text-align: center;">(Fig. 5.6-1)</p>	ON delay
	<p><b>Timer delay time</b></p> <ul style="list-style-type: none"> <li>• Sets delay time for the Timer function.</li> <li>• Available only when Timer function is selected in [A1 type] or [A2 type].</li> <li>• Setting range: 0 to 9999 seconds</li> </ul>	0 seconds
	<p><b>Direct/Reverse action</b></p> <ul style="list-style-type: none"> <li>• Selects Reverse (Heating) or Direct (Cooling) control action.</li> <li>• <i>HEAT</i>: Reverse (Heating) action</li> <li>• <i>cool</i>: Direct (Cooling) action</li> </ul>	Reverse (Heating)
	<p><b>AT bias</b></p> <ul style="list-style-type: none"> <li>• Sets bias value for AT (auto-tuning).</li> <li>• AT point is automatically determined by the deviation between PV and SV. (See Section "9. AT" on p.22)</li> <li>• Not available for direct current input or voltage input</li> <li>• Setting range: 0 to 50°C (0 to 100°F)</li> <li>• Thermocouple, RTD input with decimal point: 0.0 to 50.0°C (0.0 to 100.0°F)</li> </ul>	20°C
	<p><b>SVTC bias</b></p> <ul style="list-style-type: none"> <li>• Control desired value (SV) adds SVTC bias value to the value received by the SVTC command.</li> <li>• Available only when C5 option is equipped</li> <li>• Setting range: ±20% of scaling span</li> </ul>	0°C
	<p><b>OUT/OFF key function</b></p> <ul style="list-style-type: none"> <li>• Selects whether OUT/OFF key is used for Control output ON/OFF function (Fixed value control), or for Program control RUN/STOP function.</li> <li>• <i>oFF</i>: Control output ON/OFF function (Fixed value control)</li> <li>• <i>Proc</i>: Program control function</li> </ul>	Control output ON/OFF function
	<p><b>Step time unit</b></p> <ul style="list-style-type: none"> <li>• Selects Step time unit for the program control function.</li> <li>• Available when Program control function Program control is selected in [OUT/OFF key function]</li> <li>• <i>n/n</i>: Hours:Minutes</li> <li>• <i>hEc</i>: Minutes:Seconds</li> </ul>	Hours:Minutes

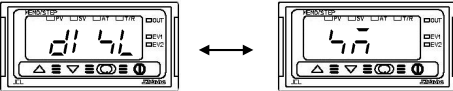
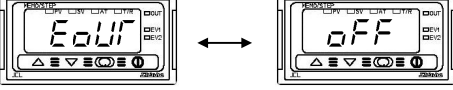
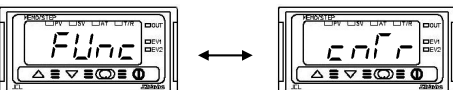
Display	Item, Function, Setting range	Factory Default												
	<p><b>DI input function</b> <span style="float: right;">SV1/SV2 external selection function</span></p> <ul style="list-style-type: none"> <li>• Selects DI input function from; SV1/SV2 external selection function, ON/OFF (RUN/STOP) external selection function, Timer function.</li> </ul> <p><b>If SV1/SV2 external selection function is selected:</b>  SV1 or SV2 can be switched by external contact.  However, available when Control output ON/OFF function (Fixed value control) is selected in [OUT/OFF key function].  Between DI terminals Open: SV1  Between DI terminals Closed: SV2</p> <p><b>If ON/OFF (RUN/STOP) external selection function is selected:</b>  Control output ON/OFF (Fixed value control) or Program control RUN/STOP can be switched.</p> <p><b>Fixed value control</b>  Between DI terminals Open: ON (Control allowed)  Between DI terminals Closed: OFF (Control prohibited, control output OFF)</p> <p><b>Program control</b>  Program control RUN/STOP can be switched if the following operation is conducted in program control standby.  DI terminals from Open to Closed: RUN (program control RUN)  DI terminals from Closed to Open: STOP (program control STOP)  If DI terminal contact is changed from Closed to Open while pattern end output is turned on after program control ended, pattern end output will be turned off.</p> <table border="1" data-bbox="667 958 1453 1128"> <tr> <td>Controller status</td> <td>Standby mode</td> <td>Program control RUN</td> <td>Program control STOP</td> </tr> <tr> <td>DI ON Contact Closed</td> <td>Contact Open</td> <td>Contact Closed</td> <td>Contact Open</td> </tr> <tr> <td>DI OFF Contact Open</td> <td>Standby mode</td> <td>Performs program control</td> <td>Stops program control.</td> </tr> </table> <p style="text-align: center;"> <span style="margin-right: 200px;">Program control is performed when the contact is changed from Open to Closed.</span> <span>Program control stops when the contact is changed from Closed to Open.</span> </p> <ul style="list-style-type: none"> <li>• <b>If Timer function is selected:</b>  Timer counting starts by the external contact, and after the preset Timer delay time has passed, the selected event output is turned on.</li> <li>• Not available if C5 option is applied.</li> <li>• <code>4n□□</code>: SV1/SV2 external selection function</li> <li>• <code>ou□□</code>: ON/OFF (RUN/STOP) external selection function</li> <li>• <code>tr□□</code>: Timer function</li> </ul>	Controller status	Standby mode	Program control RUN	Program control STOP	DI ON Contact Closed	Contact Open	Contact Closed	Contact Open	DI OFF Contact Open	Standby mode	Performs program control	Stops program control.	
Controller status	Standby mode	Program control RUN	Program control STOP											
DI ON Contact Closed	Contact Open	Contact Closed	Contact Open											
DI OFF Contact Open	Standby mode	Performs program control	Stops program control.											
	<p><b>Output status when input errors occur</b> <span style="float: right;">Output OFF</span></p> <ul style="list-style-type: none"> <li>• Selects the output status of OUT1 (OUT2) when direct current or voltage input is overscale or underscale. See "Input error indication" (p.27).</li> <li>• Available only for direct current and voltage inputs, and direct current output.</li> <li>• <code>ouFF□</code>: OUT1: Outputs OFF (4 mA) or OUT1 low limit value. OUT2: OFF</li> <li>• <code>ouon□</code>: OUT1: Outputs a value between OFF (4mA) and ON (20mA), or a value between OUT1 low limit value and OUT1 high limit value. OUT2: ON</li> </ul>													
	<p><b>Controller/Converter function</b> <span style="float: right;">Controller</span></p> <ul style="list-style-type: none"> <li>• Selects whether to use the JCL-33A as a controller or a converter.</li> <li>• <b>If the JCL-33A is switched from a converter to a controller, control parameters which were automatically set when converter function was selected are maintained as they were. Therefore, correct the values when using the JCL-33A as a controller.</b></li> <li>• Available only for direct current output type</li> <li>• <code>cntr</code>: Controller</li> <li>• <code>cnbr</code>: Converter</li> </ul>													

# 6. Settings

## 6.1 Main Setting Mode

To enter Main setting mode, press the  key in PV/SV Display mode.

Use the  $\Delta$  or  $\nabla$  key for settings (or selections), and register them with the  key.

In Main setting mode, indicated setting items differ depend on the instrument status (Fixed value control or Program control).

- Fixed value control  
SV1 and SV2 will be indicated.



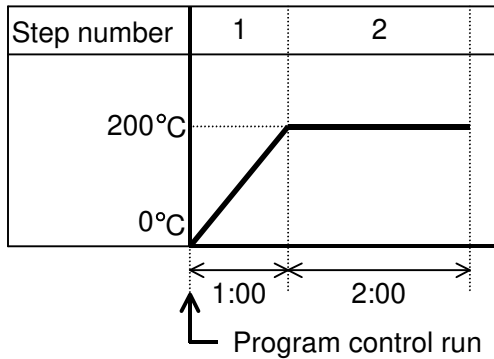





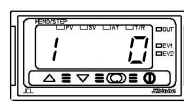

- Program control  
Step SV and step time for Steps 1 to 9 will be indicated.



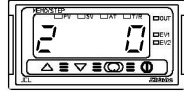

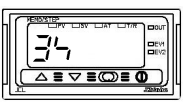
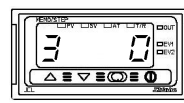

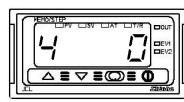

This program pattern shows that the temperature rises to 200°C for 1 hour and stays at 200°C for 2 hours.

In this case, Step 1 SV is 200°C and Step 1 time is 1 hour.

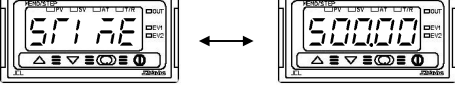
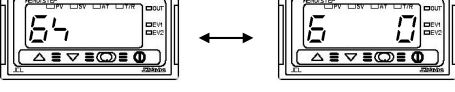

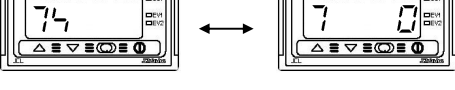
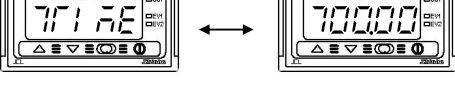
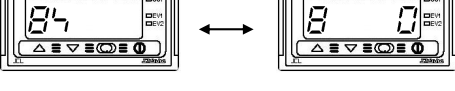

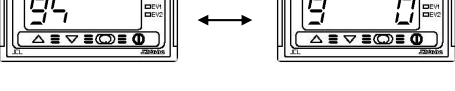
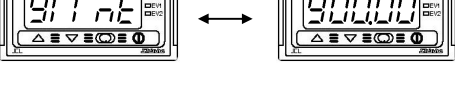

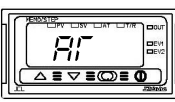
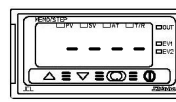
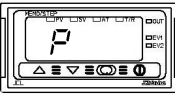
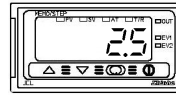

(Fig.6.1-1)

Display	Item, Function, Setting range	Factory Default
 ↔ 	<b>SV1 (Step 1 SV)</b> • Sets SV1 or Step 1 SV. • Setting range: Scaling low limit value to Scaling high limit value	0°C
 ↔ 	<b>Step 1 time</b> • Sets Step 1 time. • Available only when Program control function is selected in [OUT/OFF key function] • Setting range: 00:00 to 99:59	00:00
 ↔ 	<b>SV2 (Step 2 SV)</b> • Sets SV2 or Step 2 SV. • Available when SV1/SV2 external selection function is selected in [DI input function], or when Program control function is selected in [OUT/OFF key function]. • Setting range: Scaling low limit value to Scaling high limit value	0°C
 ↔ 	<b>Step 2 time</b> • Sets Step 2 time. • Available only when Program control function is selected in [OUT/OFF key function] • Setting range: 00:00 to 99:59	00:00
 ↔ 	<b>Step 3 SV</b> • Sets Step 3 SV. • Available only when Program control function is selected in [OUT/OFF key function] • Setting range: Scaling low limit value to Scaling high limit value	0°C
 ↔ 	<b>Step 3 time</b> • Sets Step 3 time. • Available only when Program control function is selected in [OUT/OFF key function] • Setting range: 00:00 to 99:59	00:00
 ↔ 	<b>Step 4 SV</b> • Sets Step 4 SV. • Available only when Program control function is selected in [OUT/OFF key function] • Setting range: Scaling low limit value to Scaling high limit value	0°C

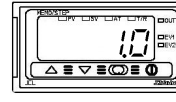
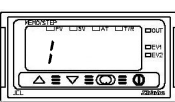
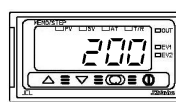
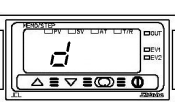
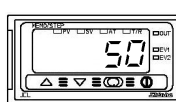
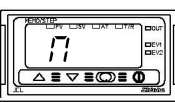
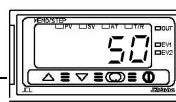
Display	Item, Function, Setting range	Factory Default
	<b>Step 4 time</b> <ul style="list-style-type: none"> <li>• Sets Step 4 time.</li> <li>• Available only when Program control function is selected in [OUT/OFF key function]</li> <li>• Setting range: 00:00 to 99:59</li> </ul>	00:00
	<b>Step 5 SV</b> <ul style="list-style-type: none"> <li>• Sets Step 5 SV.</li> <li>• Available only when Program control function is selected in [OUT/OFF key function]</li> <li>• Setting range: Scaling low limit value to Scaling high limit value</li> </ul>	0°C
	<b>Step 5 time</b> <ul style="list-style-type: none"> <li>• Sets Step 5 time.</li> <li>• Available only when Program control function is selected in [OUT/OFF key function]</li> <li>• Setting range: 00:00 to 99:59</li> </ul>	00:00
	<b>Step 6 SV</b> <ul style="list-style-type: none"> <li>• Sets Step 6 SV.</li> <li>• Available only when Program control function is selected in [OUT/OFF key function]</li> <li>• Setting range: Scaling low limit value to Scaling high limit value</li> </ul>	0°C
	<b>Step 6 time</b> <ul style="list-style-type: none"> <li>• Sets Step 6 time.</li> <li>• Available only when Program control function is selected in [OUT/OFF key function]</li> <li>• Setting range: 00:00 to 99:59</li> </ul>	00:00
	<b>Step 7 SV</b> <ul style="list-style-type: none"> <li>• Sets Step 7 SV.</li> <li>• Available only when Program control function is selected in [OUT/OFF key function]</li> <li>• Setting range: Scaling low limit value to Scaling high limit value</li> </ul>	0°C
	<b>Step 7 time</b> <ul style="list-style-type: none"> <li>• Sets Step 7 time.</li> <li>• Available only when Program control function is selected in [OUT/OFF key function]</li> <li>• Setting range: 00:00 to 99:59</li> </ul>	00:00
	<b>Step 8 SV</b> <ul style="list-style-type: none"> <li>• Sets Step 8 SV.</li> <li>• Available only when Program control function is selected in [OUT/OFF key function]</li> <li>• Setting range: Scaling low limit value to Scaling high limit value</li> </ul>	0°C
	<b>Step 8 time</b> <ul style="list-style-type: none"> <li>• Sets Step 8 time.</li> <li>• Available only when Program control function is selected in [OUT/OFF key function]</li> <li>• Setting range: 00:00 to 99:59</li> </ul>	00:00
	<b>Step 9 step SV</b> <ul style="list-style-type: none"> <li>• Sets Step 9 SV.</li> <li>• Available only when Program control function is selected in [OUT/OFF key function]</li> <li>• Setting range: Scaling low limit value to Scaling high limit value</li> </ul>	0°C
	<b>Step 9 time</b> <ul style="list-style-type: none"> <li>• Sets Step 9 time.</li> <li>• Available only when Program control function is selected in [OUT/OFF key function]</li> <li>• Setting range: 00:00 to 99:59</li> </ul>	00:00

## 6.2 Sub Setting Mode

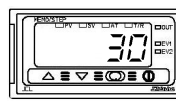
To enter Sub setting mode, press the  $\Delta$  and  $\odot$  keys (in that order) together in PV/SV Display mode. Use the  $\Delta$  or  $\nabla$  key for settings (or selections), and register them with the  $\odot$  key.

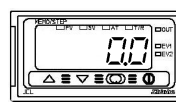
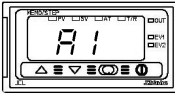
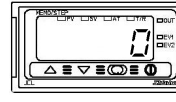
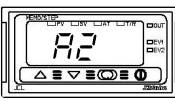
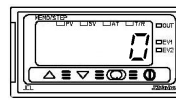
Display	Item, Function, Setting range	Factory Default
 	<b>AT (Auto-tuning)</b> <ul style="list-style-type: none"> <li>• Selects AT (auto-tuning) Perform/Cancel. Available for PID control.</li> <li>• Not available for program control standby status</li> <li>• - - - -: AT Cancel, <math>\overline{AT}</math>: AT Perform</li> </ul>	AT Cancel
 	<b>OUT1 proportional band</b> <ul style="list-style-type: none"> <li>• Sets the proportional band for OUT1.</li> <li>• OUT1 becomes ON/OFF control when set to 0.0.</li> <li>• Setting range: 0.0 to 110.0%</li> </ul>	2.5%
 	<b>OUT2 proportional band</b> <ul style="list-style-type: none"> <li>• Sets the proportional band for OUT2.</li> <li>• OUT2 becomes ON/OFF control when set to 0.0.</li> <li>• Available when DR option is applied.</li> <li>• Not available if OUT1 is ON/OFF control</li> <li>• Setting range: 0.0 to 10.0 times (Multiplied value of OUT1 p-band)</li> </ul>	1.0 times
 	<b>Integral time</b> <ul style="list-style-type: none"> <li>• Sets the integral time for OUT1.</li> <li>• Setting the value to 0 disables the function.</li> <li>• Not available if OUT1 is ON/OFF control</li> <li>• Setting range: 0 to 1000 seconds</li> </ul>	200 seconds
 	<b>Derivative time</b> <ul style="list-style-type: none"> <li>• Sets the derivative time for OUT1.</li> <li>• Setting the value to 0 disables the function.</li> <li>• Not available if OUT1 is ON/OFF control</li> <li>• Setting range: 0 to 300 seconds</li> </ul>	50 seconds
 	<b>ARW</b> <ul style="list-style-type: none"> <li>• Sets the ARW (anti-reset windup) for OUT1.</li> <li>• Available only for PID control</li> <li>• Setting range: 0 to 100%</li> </ul>	50%
 	<b>OUT1 proportional cycle</b> <ul style="list-style-type: none"> <li>• Sets OUT1 proportional cycle.</li> <li>• For relay contact output, if proportional cycle time is decreased, the frequency of the relay actions increases, and the life of the relay contact is shortened.</li> <li>• Not available for direct current output, or if OUT1 is ON/OFF control.</li> <li>• Setting range: 1 to 120 seconds</li> </ul>	Relay contact: 30 sec Non-contact voltage: 3 sec
 	<b>OUT2 proportional cycle</b> <ul style="list-style-type: none"> <li>• Sets OUT2 proportional cycle.</li> <li>• For relay contact output, if proportional cycle time is decreased, the frequency of the relay actions increases, and the life of the relay contact is shortened.</li> <li>• Available when DR option is applied.</li> <li>• Not available if OUT1 is ON/OFF control</li> <li>• Setting range: 1 to 120 seconds</li> </ul>	30 seconds
 	<b>Manual reset</b> <ul style="list-style-type: none"> <li>• Sets the reset value manually.</li> <li>• Available only for P or PD control.</li> <li>• Setting range: <math>\pm</math>Proportional band converted value (For DC input, the placement of the decimal point follows the selection.)</li> </ul>	0.0°C
 	<b>A1 value</b> <ul style="list-style-type: none"> <li>• Sets A1 action point.</li> <li>• Setting the value to 0 or 0.0 disables the function (except Process high and Process low alarm).</li> <li>• Not available if No alarm action, Timer function or Pattern end output is selected in [A1 type]</li> <li>• Setting range: See (Table 6.2-1) on p.17.</li> </ul>	0°C
 	<b>A2 value</b> <ul style="list-style-type: none"> <li>• Sets A2 action point.</li> <li>• Setting the value to 0 or 0.0 disables the function (except Process high and Process low alarm).</li> <li>• Not available if No alarm action, Timer function or Pattern end output is selected in [A2 type]</li> <li>• Setting range: See (Table 6.2-1) on p.17.</li> </ul>	0°C



(Table 6.2-1)

Alarm type	Setting range
High limit alarm	-(Scaling span) to Scaling span
Low limit alarm	-(Scaling span) to Scaling span
High/Low limits alarm	0 to Scaling span
High/Low limit range alarm	0 to Scaling span
Process high alarm	Scaling low limit to Scaling high limit value
Process low alarm	Scaling low limit to Scaling high limit value
High limit with standby alarm	-(Scaling span) to Scaling span
Low limit with standby alarm	-(Scaling span) to Scaling span
High/Low limits w/standby alarm	0 to Scaling span

For the inputs with a decimal point, the negative low limit value is -199.9, and the positive high limit value is 999.9.

All alarm types except the Process alarm are ± deviation setting from the SV (desired value).

### 6.3 Auxiliary Function Setting Mode 1

To enter Auxiliary function setting mode 1, press the  $\nabla$  and  $\odot$  keys (in that order) together for approx. 3 seconds in PV/SV Display mode.

Use the  $\Delta$  or  $\nabla$  key for settings (or selections), and register them with the  $\odot$  key.

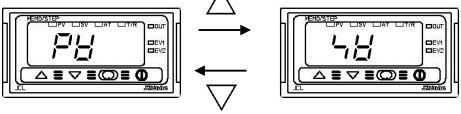
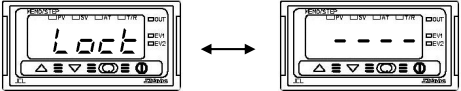
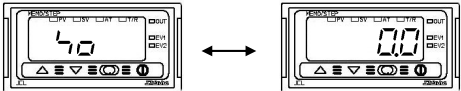
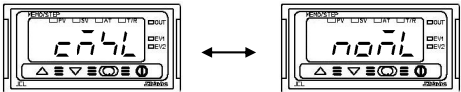
Display	Item, Function, Setting range	Factory Default
	<b>PV/SV indication</b> <ul style="list-style-type: none"> <li>PV indication or SV indication can be selected in PV/SV Display.</li> <li>When input errors occur, <math>\text{---}</math> or <math>\text{---}</math> flashes on the PV/SV Display even while SV is indicated on the display.</li> </ul>	PV indication
	<b>Set value lock</b> <ul style="list-style-type: none"> <li>Locks the set values to prevent setting errors. The setting item to be locked depends on the selection.</li> <li>When Lock 1 or Lock 2 is selected, AT (Auto-tuning) cannot be carried out.</li> <li>Be sure to select Lock 3 when changing the set value frequently via software communication because limited entries can be stored in non-volatile IC memory.</li> <li><math>\text{---}</math> (Unlock): All set values can be changed.</li> <li><math>\text{Loc 1}</math> (Lock 1): None of the set values can be changed.</li> <li><math>\text{Loc 2}</math> (Lock 2): Only SV1 and SV2 can be changed during fixed value control. Step SV and step time can be changed during program control. Other setting items cannot be changed.</li> <li><math>\text{Loc 3}</math> (Lock 3): All set values - except Input type and Controller/Converter function - can be changed. However, they revert to their previous value after the power is turned off because they are not saved in the non-volatile IC memory.</li> </ul> <p>Do not change any setting item in Auxiliary function setting mode 2.</p> <p>If any item in Auxiliary function setting mode 2 is changed, it will affect other setting items such as SV and Alarm value.</p>	Unlock
	<b>Sensor correction</b> <ul style="list-style-type: none"> <li>Sets the correction value for the sensor.</li> <li><math>\text{PV} = \text{Current PV} + \text{Sensor correction value}</math></li> <li>Setting range: <math>-100.0</math> to <math>100.0^\circ\text{C}</math> (°F), or <math>-1000</math> to <math>1000</math> (DC input)</li> </ul>	$0.0^\circ\text{C}$
	<b>Communication protocol</b> <ul style="list-style-type: none"> <li>Selects communication protocol.</li> <li>Available only when the C5 option is applied.</li> <li><math>\text{noñL}</math>: Shinko protocol</li> <li><math>\text{ñodR}</math>: Modbus ASCII mode</li> <li><math>\text{ñodr}</math>: Modbus RTU mode</li> <li><math>\text{bnñL}</math>: Shinko protocol (Block Read/Write available)</li> <li><math>\text{bñdR}</math>: Modbus ASCII mode (Block Read/Write available)</li> <li><math>\text{bñdr}</math>: Modbus RTU mode (Block Read/Write available)</li> </ul>	Shinko protocol

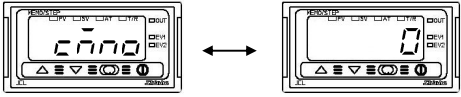
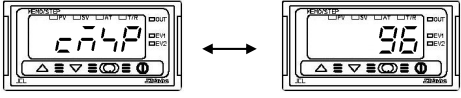
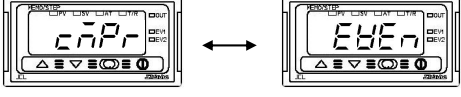
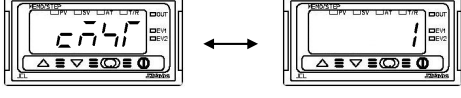
Display	Item, Function, Setting range	Factory Default
	<b>Instrument number</b> <ul style="list-style-type: none"> <li>• Sets the instrument number.</li> <li>The instrument numbers should be set one by one when multiple instruments are connected in Serial communication, otherwise communication is impossible.</li> <li>• Available only when C5 option is equipped.</li> <li>• Setting range: 0 to 95</li> </ul>	0
	<b>Communication speed</b> <ul style="list-style-type: none"> <li>• Selects a communication speed equal to that of the host computer.</li> <li>• Available only when C5 option is equipped.</li> <li>• Selection item: <ul style="list-style-type: none"> <li><input type="checkbox"/> 24 : 2400 bps</li> <li><input type="checkbox"/> 48 : 4800 bps</li> <li><input type="checkbox"/> 96 : 9600 bps</li> <li><input type="checkbox"/> 192 : 19200 bps</li> <li><input type="checkbox"/> 384 : 38400 bps</li> </ul> </li> </ul>	9600 bps
	<b>Parity</b> <ul style="list-style-type: none"> <li>• Selects the parity equal to that of the host computer.</li> <li>• Available only when C5 option is equipped.</li> <li>• Selection item: <ul style="list-style-type: none"> <li><i>nonE</i>: No parity</li> <li><i>EVEN</i>: Even</li> <li><i>odd</i>: Odd</li> </ul> </li> </ul>	Even
	<b>Stop bit</b> <ul style="list-style-type: none"> <li>• Selects the stop bit equal to that of the host computer.</li> <li>• Available only when C5 option is equipped.</li> <li>• Selection item: <ul style="list-style-type: none"> <li><input type="checkbox"/> 1 : 1 bit</li> <li><input type="checkbox"/> 2 : 2 bits</li> </ul> </li> </ul>	1 bit

## 7. Operation

### 7.1 Starting Operation.

After the controller is mounted to the control panel, and wiring is completed, operate the unit following the procedure below.

#### (1) Turn the power supply to the JCL-33A ON.

For approx. 3 sec after the power is switched ON, the sensor input characters and the temperature unit are indicated on the PV/SV Display. See (Table 5-1) on p.8.

During this time, all outputs and LED indicators are in OFF status.

After that, the following will be indicated depending on the controller status.

#### • Fixed value control status

Control starts, indicating memory number on the MEMO/STEP Display, and PV (input value) or SV (desired value) on the PV/SV Display. (If PV indication is selected in [PV/SV indication], PV will be indicated. If SV indication is selected in [PV/SV indication], SV will be indicated.)

#### • Program control standby status

The MEMO/STEP Display is unlit, and the PV/SV Display indicates PV or *47.53*.

(If PV indication is selected in [PV/SV indication], PV will be indicated. If SV indication is selected, *47.53* will be indicated.)

#### • Program control RUN status

The MEMO/STEP Display indicates the step number, and the PV/SV Display indicates PV or current step SV. (If PV indication is selected in [PV/SV indication], PV will be indicated. If SV indication is selected, current step SV will be indicated.)

#### • When control output OFF function is working;

The MEMO/STEP Display is unlit, and the PV/SV Display indicates *OFF*.

#### (2) Input each set value.

Enter each set value. Refer to Section "6. Settings".

### (3) Turn the load circuit power ON.

The controller starts as follows depending on the settings.

- **Fixed value control**

Control starts so as to keep the control target at the SV.

- **Program control**

#### Program control RUN

To perform program control, press the  key. At this time the program control starts with the PV Start.

PV Start: When the program control starts, SV and step time are advanced to the PV, then the program control is performed.

#### Program control STOP

To stop program control, press the  key again for approx. 1 second. The program control stops, and the controller reverts to program control standby mode.

#### Action after power is restored

If power failure occurs during the program control RUN, the control resumes from the point at which power failure occurred.

If power failure occurs during program control standby mode, the control resumes from program control standby mode.

Progressing time error after power is restored: Within  $\pm 1$  minute regardless of step time unit

- **Converter**

Each input value (thermocouple, RTD, Direct current, DC voltage) is converted to 4 to 20 mA DC, and is output.

Input/output response is approx. 1 second.

To use an alarm, select Process alarm in [A1 type] or [A2 type].



## 7.2 MV (Output Manipulated Variable) Indication

To indicate MV, press and hold down the  key for approx. 3 seconds in PV/SV Display mode.

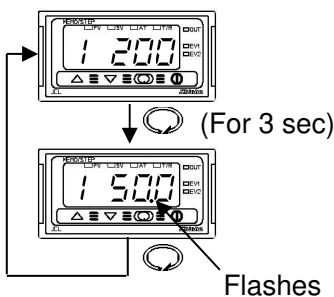
Keep pressing the  key until MV appears, though SV1 (Step 1 SV) appears during the process.



#### PV/SV Display mode

Press and hold down the  key for approx. 3 seconds. Keep pressing the  key until MV appears, though SV1 (Step 1 SV) appears during the process.

#### MV indication

The MEMO/STEP Display indicates a memory number during Fixed value control, and a step number during Program control. The PV/SV Display indicates MV. While MV is being indicated, the 1st decimal point from the right flashes in 0.5 second cycles.

To cancel MV indication, press the  key again, or turn the power of the JCL-33A OFF, then ON again.

## 7.3 Control output OFF function

The control action and output of an instrument (or instruments) can be turned OFF without turning OFF their power supplies using this function.

To turn the control output OFF, press the  key for approx. 1 second in PV/SV Display mode.

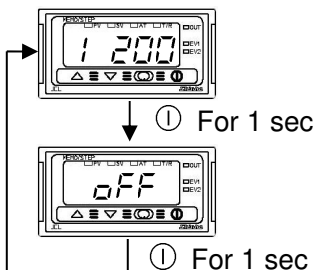

#### PV/SV Display mode

Press the  key for approx. 1 second.

#### Control output OFF

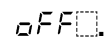
The MEMO/STEP Display is unlit, and the PV/SV Display indicates .

Once the control output OFF function is enabled, the function cannot be cancelled even if the power to the instrument is turned OFF and ON again.

To cancel the function, press the  key again for approx. 1 second.

## 7.4 AT Perform/Cancel



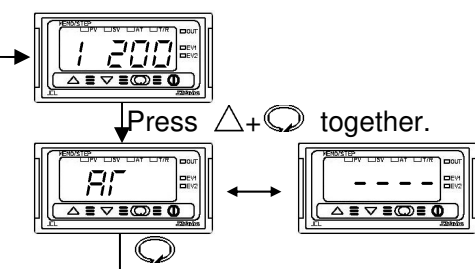

AT Perform/Cancel can be selected in [AT] in Sub setting mode.



#### PV/SV Display mode

Press the  and  keys (in that order) together.

#### Selecting AT in Sub setting mode

Select AT Perform () with the  key, or AT Cancel (----) with the  key, then press the  key.

The AT indicator flashes while performing AT.

If AT is cancelled during the process, P, I, D, ARW values return to the previous values.

AT will be forced to stop if it has not been completed within 4 hours.

# 8. Operation Flowchart

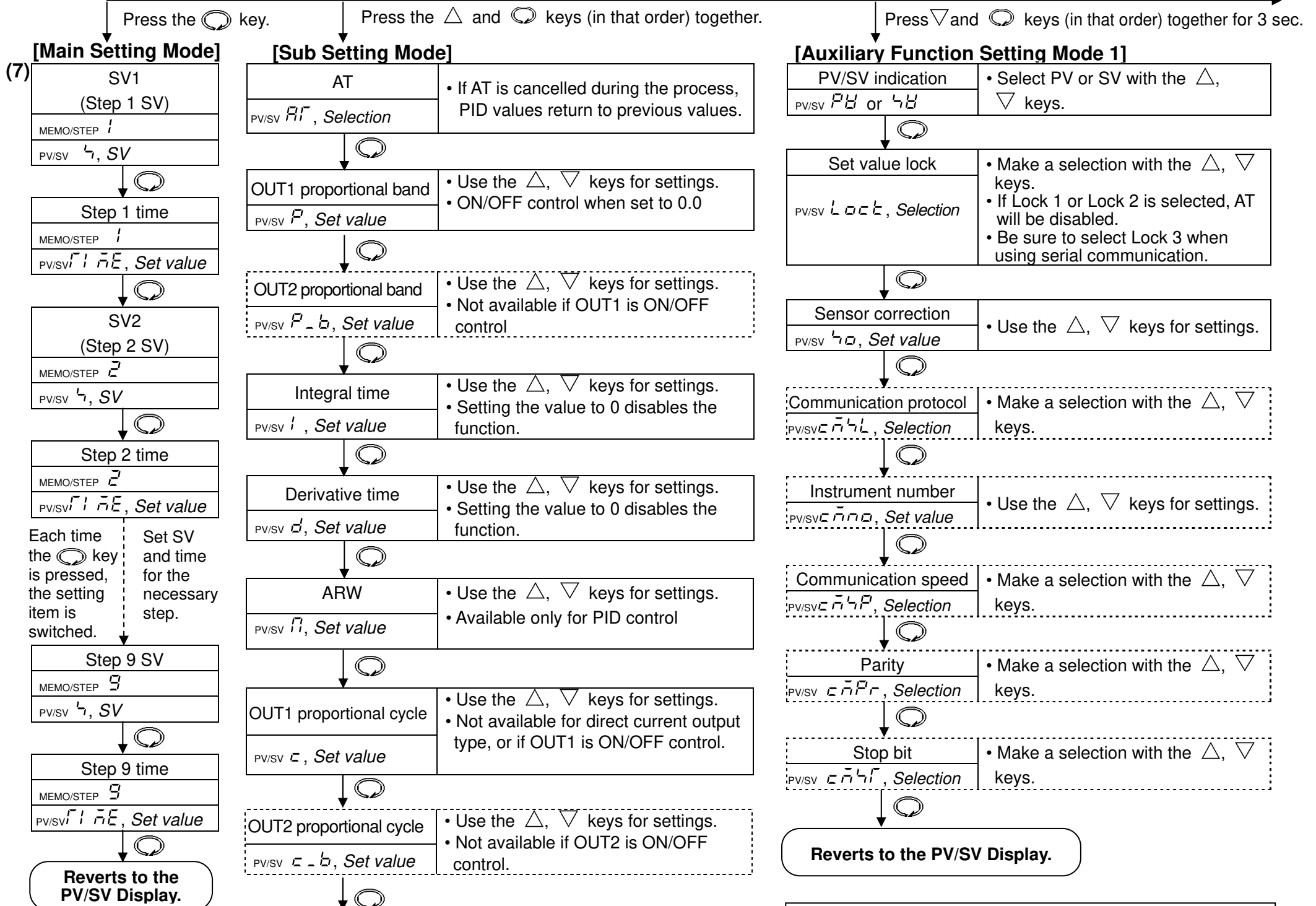
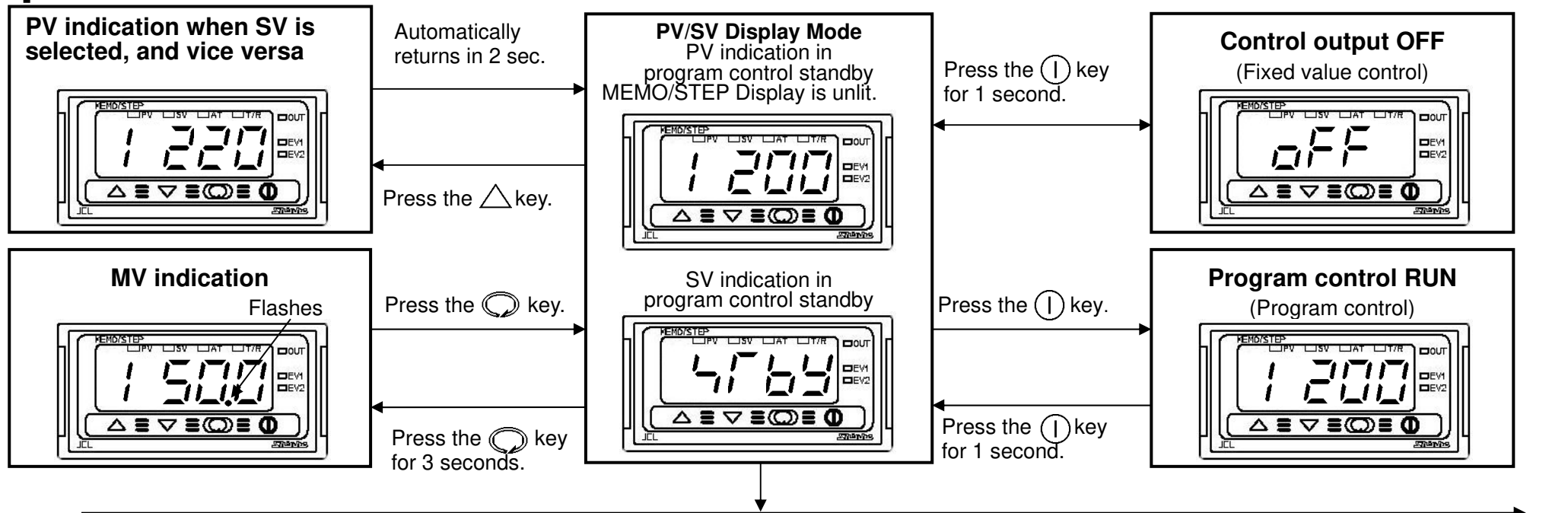

**About  $\odot$  Key**

$\odot$ : This means that if the  $\odot$  key is pressed, the set value will be saved, and the controller will proceed to the next setting item, illustrated by an arrow.

- If the  $\odot$  key is pressed for approx. 3sec, the controller reverts to the PV/SV display mode from any mode.

**Character Indication**

- Characters and the set (selected) value of the setting item are indicated on the PV/SV display alternately.
- Setting items with dotted lines are optional, and they appear only when the options are equipped.

**Basic operation procedure:**

Set the input type, alarm (type, value, etc.), SV.

[Numbers (1) to (7) are indicated on the flowchart.]

**Step 1:** Turn the load circuit power OFF, and turn the power supply to the JCL-33A ON.

**Step 2: Auxiliary function setting mode 2**

- [Input type]: Select an input type. (See "Input type" on p.21.)
- [A1 type]: Select an alarm type.  
If ----,  $\Gamma$  or  $P.End$  is selected, items (3) to (6) will not be indicated.  
**If an alarm type is changed, the alarm value becomes 0 (0.0). Therefore, it is necessary to set it again.**
- [A1 hysteresis]: Set A1 hysteresis.
- [A1 delay time]: Set A1 action delay time.
- [Alarm Hold function]: Select "Alarm Not holding" or "Alarm Holding". (Common to A1 and A2)

**Step 3: Sub setting mode**

- [A1 value]: Set an action point for A1 output.

**Step 4: Main setting mode**

- [SV1]: Set SV.

**Step 5: Operation**

Turn the load circuit power ON. Control action starts so as to keep the control target at the SV.

Input Type (Character indication) and Range			
$t_{\square\square\square}C$ : K	-200 to 1370 °C	$t_{\square\square\square}F$ : K	-320 to 2500 °F
$t_{\square\square\square}C$ :	-199.9 to 400.0 °C	$t_{\square\square\square}F$ :	-199.9 to 750.0 °F
$J_{\square\square\square}C$ : J	-200 to 1000 °C	$J_{\square\square\square}F$ : J	-320 to 1800 °F
$r_{\square\square\square}C$ : R	0 to 1760 °C	$r_{\square\square\square}F$ : R	0 to 3200 °F
$s_{\square\square\square}C$ : S	0 to 1760 °C	$s_{\square\square\square}F$ : S	0 to 3200 °F
$b_{\square\square\square}C$ : B	0 to 1820 °C	$b_{\square\square\square}F$ : B	0 to 3300 °F
$E_{\square\square\square}C$ : E	-200 to 800 °C	$E_{\square\square\square}F$ : E	-320 to 1500 °F
$T_{\square\square\square}C$ : T	-199.9 to 400.0 °C	$T_{\square\square\square}F$ : T	-199.9 to 750.0 °F
$n_{\square\square\square}C$ : N	-200 to 1300 °C	$n_{\square\square\square}F$ : N	-320 to 2300 °F
$PL2C$ : PL-II	0 to 1390 °C	$PL2F$ : PL-II	0 to 2500 °F
$c_{\square\square\square}C$ : C(W/Re5-26)	0 to 2315 °C	$c_{\square\square\square}F$ : C(W/Re5-26)	0 to 4200 °F
$Pt_{\square\square}C$ : Pt100	-199.9 to 850.0 °C	$Pt_{\square\square}F$ : Pt100	-199.9 to 999.9 °F
$JPt_{\square\square}C$ : JPt100	-199.9 to 500.0 °C	$JPt_{\square\square}F$ : JPt100	-199.9 to 900.0 °F
$Pt_{\square\square}C$ : Pt100	-200 to 850 °C	$Pt_{\square\square}F$ : Pt100	-300 to 1500 °F
$JPt_{\square\square}C$ : JPt100	-200 to 500 °C	$JPt_{\square\square}F$ : JPt100	-300 to 900 °F
$420A$ : 4 to 20 mA DC	-1999 to 9999	$010V$ : 0 to 1 V DC	-1999 to 9999
$020A$ : 0 to 20 mA DC	-1999 to 9999	$050V$ : 0 to 5 V DC	-1999 to 9999
		$150V$ : 1 to 5 V DC	-1999 to 9999
		$010V$ : 0 to 10 V DC	-1999 to 9999

Alarm Type	
$H_{\square\square\square}$ (High limit alarm):	The alarm action is $\pm$ deviation setting from the SV. The alarm is activated if the input value reaches the high limit set value.
$L_{\square\square\square}$ (Low limit alarm):	The alarm action is $\pm$ deviation setting from the SV. The alarm is activated if the input value goes under the low limit set value.
$HL_{\square\square}$ (High/Low limits alarm):	Combines High limit and Low limit alarm actions. When input value reaches high limit set value, or goes under the low limit set value, the alarm is activated.
$HLd$ (High/Low limit range alarm):	When input value is between the high limit set value and low limit set value, the alarm is activated.
$RA_{\square\square}$ (Process high alarm), $RL_{\square\square}$ (Process low alarm):	Within the scale range of the controller, alarm action points can be set at random, and if the input reaches the randomly set action point, the alarm is activated.
$H_{\square\square}d$ (High limit with standby alarm), $L_{\square\square}d$ (Low limit with standby alarm)	
$HLd_{\square\square}$ (High/Low limits with standby alarm)	When the power to the controller is turned on, even if the input enters the alarm action range, the alarm is not activated. (If the controller is allowed to keep running, once the input exceeds the alarm action point, the standby function will be released.)
$\Gamma_{\square\square}d$ (Timer function):	If external signal enters, timer counting starts, and the action selected in [Delay action type] is output after the preset delay time has passed.
$PEnd$ (Pattern end output):	When the program ends normally, pattern end output is turned ON. The output is maintained until it is cancelled with the $\odot$ key.

Press the  $\Delta$ ,  $\nabla$  keys (in that order) together for 3 sec.

### [Auxiliary Function Setting Mode 2]

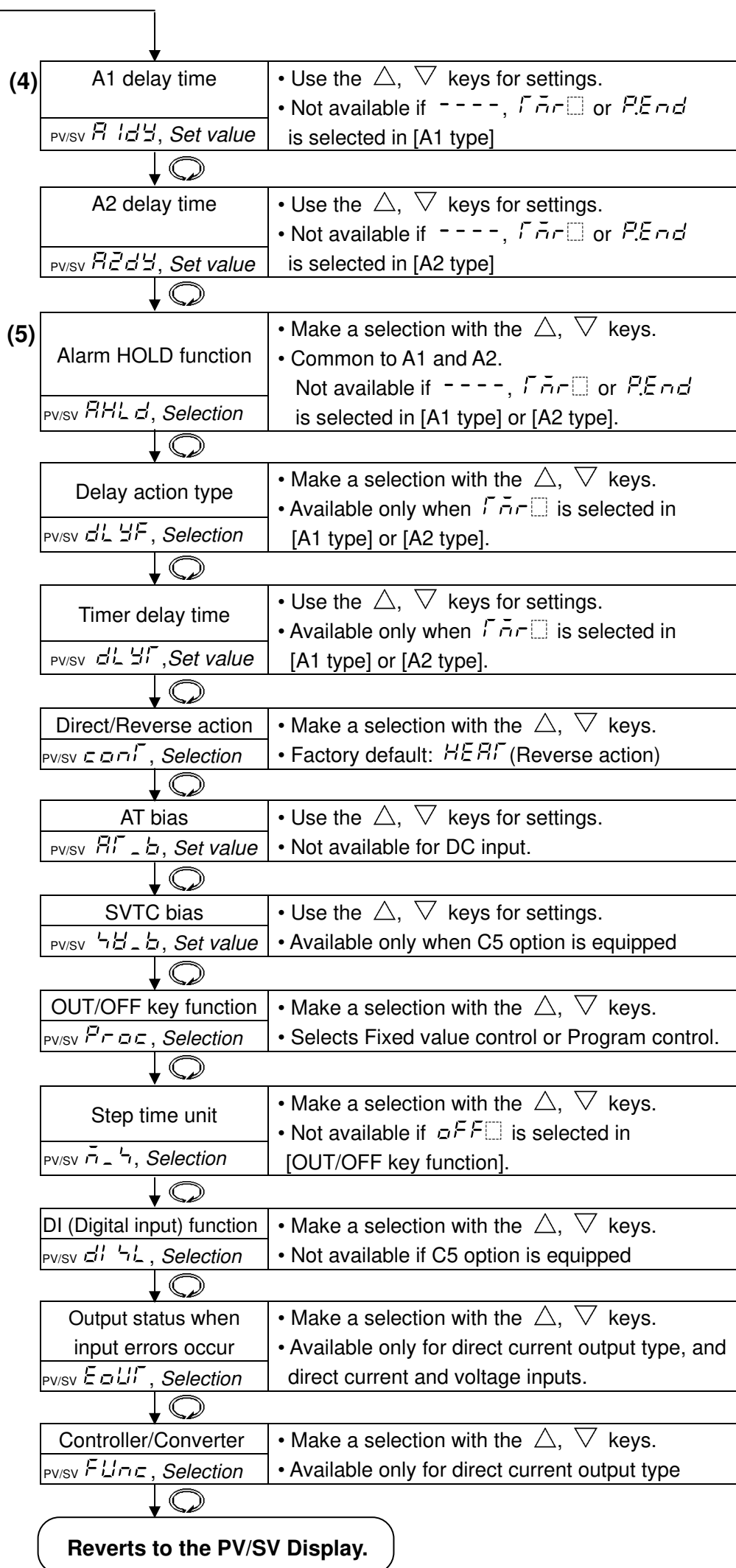
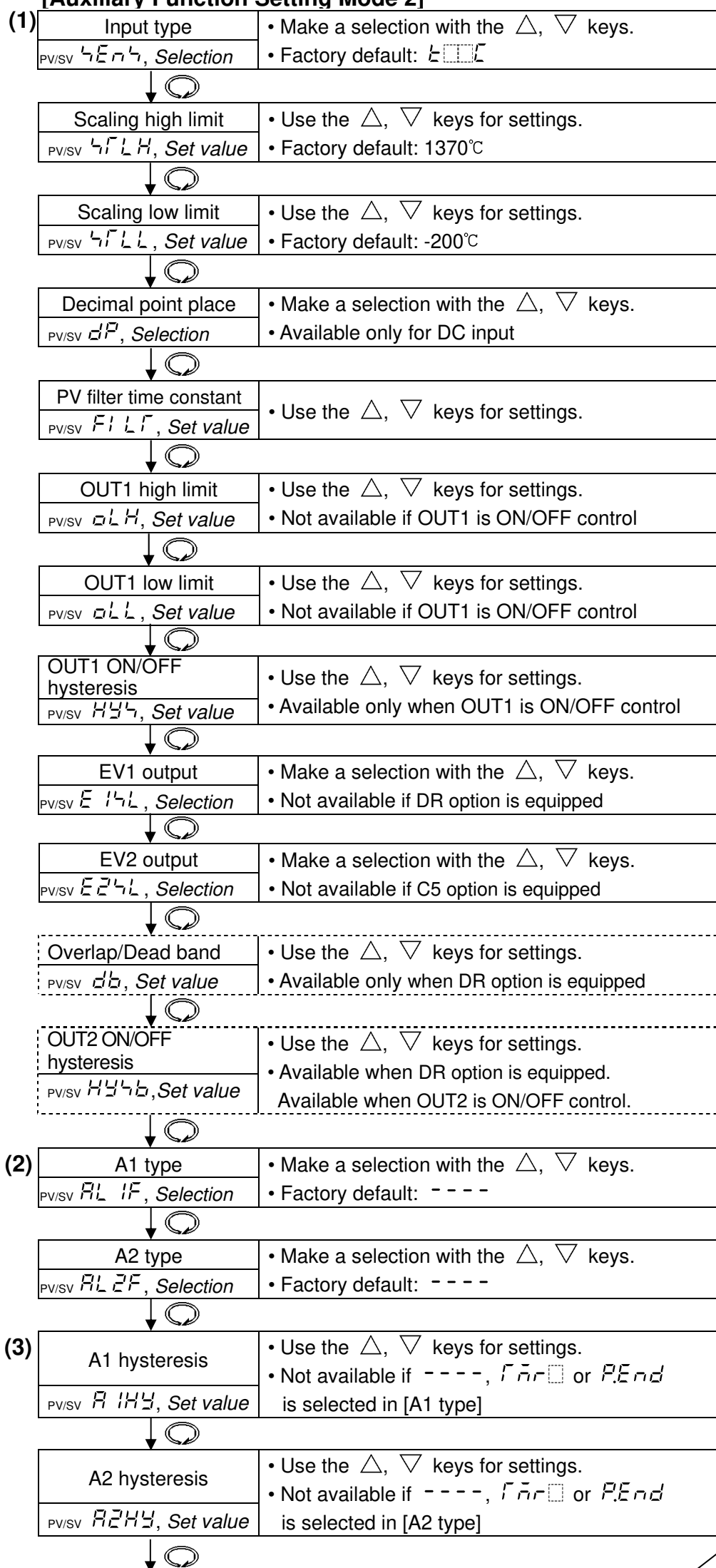

# 9. AT (Auto-Tuning)

In order to set each value of P, I, D and ARW automatically, the auto-tuning process should be made to fluctuate to obtain an optimal value. One of 3 types of fluctuation below is automatically selected. For DC input, the AT process will fluctuate around the SV for conditions of (A), (B) and (C) below.

## ⚠ Notice

- Perform AT during trial run.
- During AT, none of the setting items can be set.
- If AT starts during program control RUN, AT will perform at SV at the time of AT start. The step time does not progress until AT ends.
- If power failure occurs during AT, AT will stop.
- If AT is cancelled during the process, P, I, D and ARW values will revert to the previous value at which AT is performed.
- AT will be forced to stop if it has not been completed within 4 hours.
- Sometimes the AT process will not fluctuate if AT is performed at or near room temperature. Therefore, AT might not finish normally.

### (A) If there is a large difference between the SV and PV as the temperature is rising

When AT bias is set to 20°C, the AT process will fluctuate at the temperature 20°C lower than the SV.

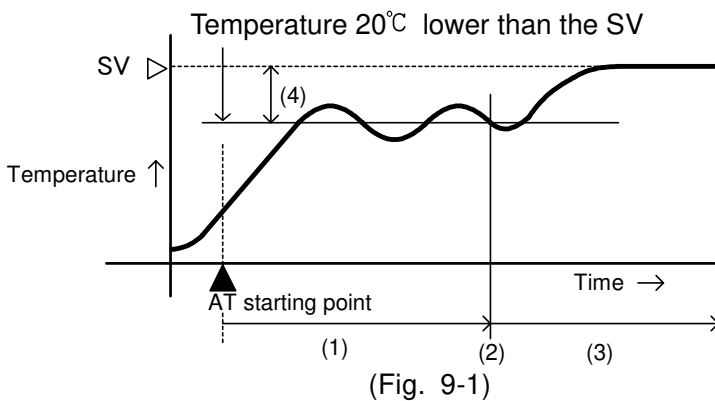

- (1) Calculates PID constant
- (2) PID constant calculated
- (3) Controlled by the PID constant set by auto-tuning.
- (4) AT bias value

### (B) When the control is stable

The AT process will fluctuate around the SV.

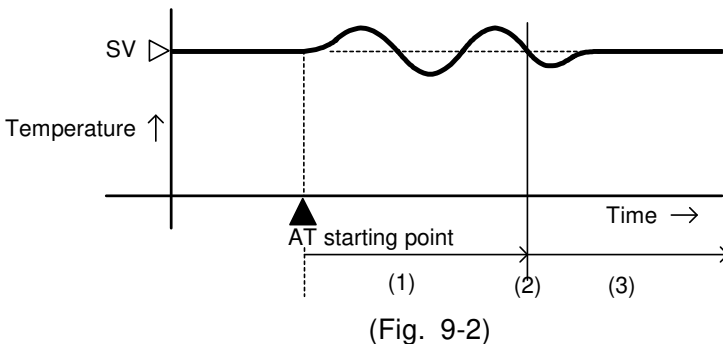

- (1) Calculates PID constant
- (2) PID constant calculated
- (3) Controlled by the PID constant set by auto-tuning.

### (C) If there is a large difference between the SV and PV as the temperature is falling

When AT bias is set to 20°C, the AT process will fluctuate at the temperature 20°C higher than the SV.

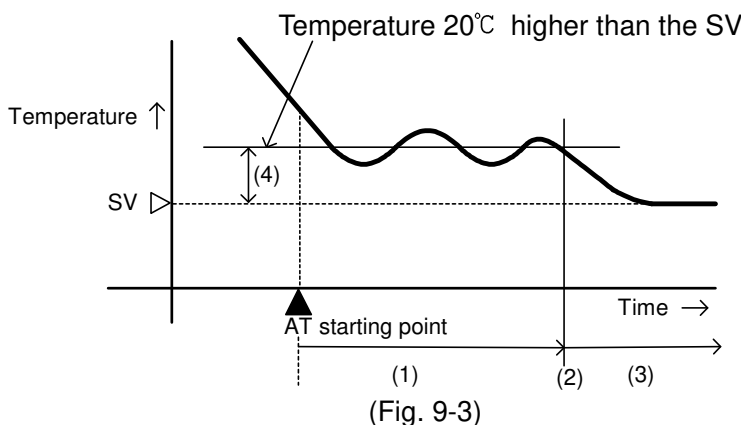

- (1) Calculates PID constant
- (2) PID constant calculated
- (3) Controlled by the PID constant set by auto-tuning.
- (4) AT bias value

# 10. Action Explanation

## 10.1 OUT1 Action

	Heating (Reverse) action	Cooling (Direct) action
Control action		
Relay contact output	<p>Cycle action is performed according to deviation.</p>	<p>Cycle action is performed according to deviation.</p>
Non-contact voltage output	<p>Cycle action is performed according to deviation.</p>	<p>Cycle action is performed according to deviation.</p>
Direct current output	<p>Changes continuously according to deviation.</p>	<p>Changes continuously according to deviation.</p>
Indicator (OUT) Green		

: Turns ON or OFF.

## 10.2 OUT1 ON/OFF Control Action

	Heating (Reverse) action	Cooling (Direct) action
Control action		
Relay contact output		
Non-contact voltage output		
Direct current output		
Indicator (OUT) Green		

: Turns ON or OFF.

### 10.3 A1, A2 Action

	High limit alarm	Low limit alarm	High/Low limits alarm
Alarm action			
	High/Low limit range alarm	Process high alarm	Process low alarm
Alarm action			
	High limit with standby alarm	Low limit with standby alarm	High/Low limits with standby alarm
Alarm action			

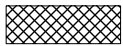

: Alarm output is in standby.

EV1 indicator lights when terminals 8 and 9 are closed, and turns off when they are open.

EV2 indicator lights when terminals 11 and 12 are closed, and turns off when they are open.

### 10.4 OUT2 (Heating/Cooling Control) Action (When DR Option is Applied)

Control action			
Relay contact output (OUT)	<p>Cycle action is performed according to deviation.</p>		
Non-contact voltage output (OUT)	<p>Cycle action is performed according to deviation.</p>		
Direct current output (OUT)	<p>Changes continuously according to deviation.</p>		
Relay contact output (EV1)	<p>Cycle action is performed according to deviation.</p>		
Indicator (OUT) Green	<p>Unlit</p>		
Indicator (EV1) Yellow	<p>Unlit</p>		



: Turns ON (lit) or OFF (unlit).

————— : Represents Heating control action.

- - - - - : Represents Cooling control action.



### 10.5 OUT2 (Heating/Cooling Control) Action (When Setting Dead Band) (When DR Option is Applied)

Control action			
Relay contact output (OUT)			
Non-contact voltage output (OUT)			
Direct current output (OUT)			
Relay contact output (EV1)			
Indicator (OUT) Green			
Indicator (EV1) Yellow			

: Turns ON (lit) or OFF (unlit).  
 — : Represents Heating control action.  
 - - - : Represents Cooling control action.

### 10.6 OUT2 (Heating/Cooling Control) Action (When Setting Overlap Band) (When DR Option is Applied)

Control action			
Relay contact output (OUT)			
Non-contact voltage output (OUT)			
Direct current output (OUT)			
Relay contact output (EV1)			
Indicator (OUT) Green			
Indicator (EV1) Yellow			

: Acts ON (lit) or OFF (unlit).  
 — : Represents Heating control action.  
 - - - : Represents Cooling control action.

### 10.7 Timer Action

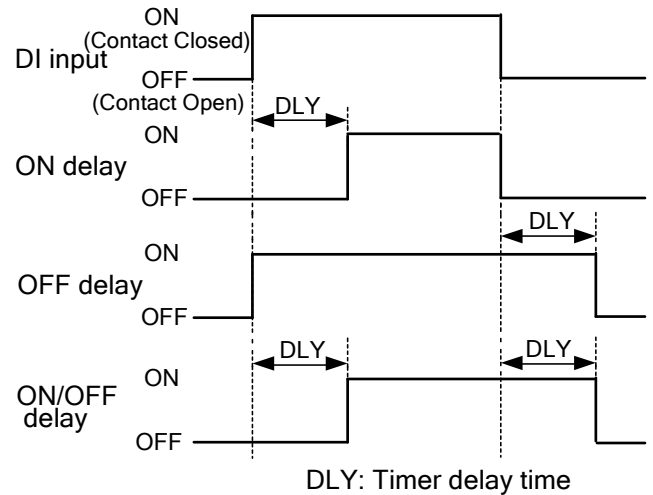

# 11. Specifications

## 11.1 Standard Specifications

**Mounting:** Flush  
**Setting:** Input system using membrane sheet key  
**Display:** PV/SV Display: Red LED 4 digits, character size 8.7 x 5 mm (H x W)  
MEMO/STEP Display: Green LED 1 digit, character size 8.7 x 5 mm (H x W)

### Accuracy (Setting and Indication):

Thermocouple: Within  $\pm 0.2\%$  of each input span  $\pm 1$  digit, or within  $\pm 2^{\circ}\text{C}$  ( $4^{\circ}\text{F}$ ), whichever is greater  
However R, S input, 0 to  $200^{\circ}\text{C}$  (32 to  $392^{\circ}\text{F}$ ): Within  $\pm 6^{\circ}\text{C}$  ( $12^{\circ}\text{F}$ )  
B input, 0 to  $300^{\circ}\text{C}$  (32 to  $572^{\circ}\text{F}$ ): Accuracy is not guaranteed  
K, J, E, T, N input, less than  $0^{\circ}\text{C}$  ( $32^{\circ}\text{F}$ ): Within  $\pm 0.4\%$  of input span  $\pm 1$  digit, or within  $\pm 4^{\circ}\text{C}$  ( $8^{\circ}\text{F}$ ), whichever is greater

RTD: Within  $\pm 0.1\%$  of each input span  $\pm 1$  digit, or within  $\pm 1^{\circ}\text{C}$  ( $2^{\circ}\text{F}$ ), whichever is greater

Direct current: Within  $\pm 0.2\%$  of each input span  $\pm 1$  digit

DC voltage: Within  $\pm 0.2\%$  of each input span  $\pm 1$  digit

### Input sampling period: 250 ms

**Input** Thermocouple: K, J, R, S, B, E, T, N, PL-II, C (W/Re5-26), External resistance:  $100\ \Omega$  max.  
(However, B input, External resistance:  $40\ \Omega$  max.)

RTD: Pt100, JPt100, 3-wire type  
Allowable input lead wire resistance ( $10\ \Omega$  max per wire)

Direct current: 0 to 20 mA DC, 4 to 20 mA DC

Input impedance:  $50\ \Omega$  [Externally connect a  $50\ \Omega$  shunt resistor (sold separately) between input terminals.]

Allowable input current: 50 mA DC max. [When a  $50\ \Omega$  shunt resistor (sold separately) is used]

DC voltage: 0 to 1 V DC: Input impedance ( $1\ \text{M}\Omega$  min.)

Allowable input voltage: 5V DC max.

Allowable signal source resistance:  $2\ \text{k}\Omega$  max.

0 to 5 V DC, 1 to 5 V DC, 0 to 10 V DC: Input impedance:  $100\ \text{k}\Omega$  min.

Allowable input voltage: 15 V DC max.)

Allowable signal source resistance ( $100\ \Omega$  max.)

**OUT1** Relay contact 1a: Control capacity 3 A 250 V AC (resistive load)  
1 A 250 V AC (inductive load  $\cos\phi=0.4$ )

Electrical life, 100,000 cycles

Non-contact voltage (For SSR drive):  $12^{\pm 2}_0$  V DC Max. 40 mA DC (short circuit protected)

Direct current: 4 to 20 mA DC, Load resistance, Max.  $550\ \Omega$

### Event output 1 (EV1), Event output 2 (EV2)

One type can be selected from 10 types of alarm action (including No alarm action), Timer function and Pattern end output.

Alarm setting range: See (Table 6.2-1) on p.17.

Action: ON/OFF action

Hysteresis: TC, RTD input:  $0.1$  to  $100.0^{\circ}\text{C}$  ( $^{\circ}\text{F}$ )  
Direct current, voltage input: 1 to 1000 (The placement of the decimal point follows the selection.)

A1, A2 delay time: 0 to 9999 seconds

Alarm HOLD function: Once the alarm is activated, the alarm output is maintained until the power supply to the instrument is turned OFF.

Timer function: 0 to 9999 seconds

Pattern end output: Pattern end output is turned on when the program ends normally.

EV1 output, Relay contact 1a: Control capacity: 3A 250V AC (resistive load)  
1A 250V AC (inductive load  $\cos\phi=0.4$ )

Electrical life, 100,000 cycles

EV2 output, Open collector: Control capacity: 0.1 A 24 V DC (maximum)

### Control action

PID control (with AT function)

PI control: When derivative time is set to 0

PD control (with manual reset function): When integral time is set to 0

P control (with manual reset function): When derivative time and integral time are set to 0.

ON/OFF control: When proportional band is set to 0

OUT1 proportional band: 0.0 to 110.0% (ON/OFF action when set to 0.0)

Integral time: 0 to 1000 sec (OFF when set to 0)

Derivative time: 0 to 300 sec (OFF when set to 0)

OUT1 proportional cycle: 1 to 120 sec (Not available for direct current output type)

ARW: 0 to 100%

Manual reset:  $\pm$ Proportional band converted value

OUT1 ON/OFF hysteresis:  $0.1$  to  $100.0^{\circ}\text{C}$  ( $^{\circ}\text{F}$ ), or 1 to 1000

OUT1 output limit: 0 to 100% (Direct current output type:  $-5$  to 105%)

**DI (Digital input):** DI has 3 functions. Circuit current when closed: 6 mA

- **SV1/SV2 external selection function:** SV1 or SV2 can be switched by external contact. However, this function is not available if Program control function is selected in [OUT/OFF key function].

DI terminals between 10 and 12 Open: SV1

DI terminals between 10 and 12 Closed: SV2

- **ON/OFF (RUN/STOP) external selection function**

Control output ON/OFF (Fixed value control) or Program control RUN/STOP can be switched.

[Fixed value control]: DI terminals between 10 and 12 Open: ON (Control allowed)

DI terminals between 10 and 12 Closed: OFF (Control prohibited, control output OFF)

[Program control]:

Program control RUN/STOP can be switched if the following operation is conducted in program control standby.

Between DI terminals (10, 12) from Open to Closed: RUN (program control RUN)

Between DI terminals (10, 12) from Closed to Open: STOP (program control STOP)

If DI terminal contact is changed from Closed to Open while pattern end output is turned on after program control ended, pattern end output is turned off.

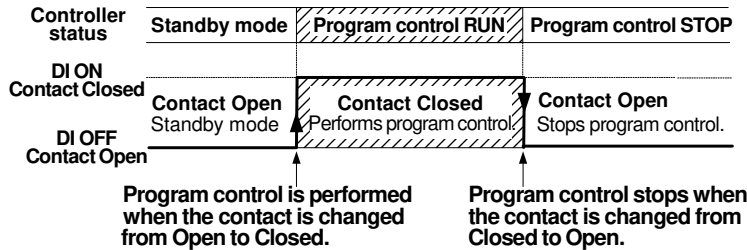

- **Timer function:** Timer counting starts by the external contact, and after the preset Timer delay time has passed, the selected event output is turned on.

**Program control function:** If program control function is selected in [OUT/OFF key function], 1 pattern 9 steps program control can be performed. To start program control, press the  $\text{\textcircled{1}}$  key in program control standby.

(To stop the program control, press the  $\text{\textcircled{1}}$  key for approx. 1 second again.)

Progressing time error: Within  $\pm 1$  minute

Pattern end output: Pattern end output can be selected by keypad.

**Converter function**

If Converter is selected in [Controller/Converter], the following control parameters are automatically set, and the controller can be used as a converter. (However, available only for direct current output type).

Input/output response: Approx. 1 second.

SV1: Scaling low limit value, Integral time: 0, Derivative time: 0, OUT1 proportional band: 100.0%,

Manual reset: 0.0, A1 value: 0, A2 value: 0, Direct/Reverse action: Direct action

**Attached functions**

**[Set value lock]:** Locks set values to prevent setting errors.

**[Sensor correction]:** The PV is corrected when sensor-measured temperature may deviate from the temperature in the controlled location.

**[PV filter]:** Reduces input fluctuation caused by noise by putting first order lag filter in the PV.

**[Automatic cold junction temperature compensation] (Only thermocouple input type):**

This detects the temperature at the connecting terminal between the thermocouple and the instrument, and always maintains it at the same status as if the reference junction temperature was at 0°C (32°F).

**[Burnout]:** When the thermocouple or RTD input is burnt out, OUT1 and OUT2 (DR option) are turned off (for direct current output type, OUT1 low limit value), and the PV/SV Display flashes . . . . .

**[Input error indication]**

		Controller/Converter Function					
		Controller				Converter	
		Output status				Output status	
Output status when input errors occur	Contents, Indication	OUT1		OUT2		OUT1	
		Direct action	Reverse action	Direct action	Reverse action	Direct action	Reverse action
$\text{ON} \square \square$	Overscale: Measured value has exceeded Indication range high limit value. " - - - - " flashes.	ON (20mA) or OUT1 high limit value(*1)	OFF(4mA) or OUT1 low limit value	OFF	ON (*2)	ON (20mA) or OUT1 high limit value	OFF(4mA) or OUT1 low limit value
$\text{OFF} \square \square$		OFF (4mA) or OUT1 low limit value			OFF		
$\text{ON} \square \square$	Underscale: Measured value has dropped below Indication range low limit. " - - - - " flashes.	OFF (4mA) or OUT1 low limit value	ON(20mA) or OUT1 high limit value (*1)	ON (*2)	OFF	OFF(4mA) or OUT1 low limit value	ON (20mA) or OUT1 high limit value
$\text{OFF} \square \square$			OFF(4mA) or OUT1 low limit value				

Only for direct current and voltage inputs, and direct current output, [Output status when input errors occur] is usable.

(\*1) Outputs a value between OFF (4 mA) and ON (20 mA), or between OUT1 (or OUT2) low limit value and OUT1 (or OUT2) high limit value, depending on deviation.

(\*2) Outputs between OFF and ON, depending on deviation.

### Thermocouple, RTD input

Input	Input Range	Indication Range	Control Range
K, T	-199.9 to 400.0°C	-199.9 to 450.0°C	-205.0 to 450.0°C
	-199.9 to 750.0°F	-199.9 to 850.0°F	-209.0 to 850.0°F
Pt100	-199.9 to 850.0°C	-199.9 to 900.0°C	-210.0 to 900.0°C
	-200 to 850°C	-210 to 900°C	-210 to 900°C
	-199.9 to 999.9°F	-199.9 to 999.9°F	-211.0 to 1099.9°F
JPt100	-300 to 1500°F	-318 to 1600°F	-318 to 1600°F
	-199.9 to 500.0°C	-199.9 to 550.0°C	-206.0 to 550.0°C
	-200 to 500°C	-207 to 550°C	-207 to 550°C
	-199.9 to 900.0°F	-199.9 to 999.9°F	-211.0 to 999.9°F
	-300 to 900°F	-312 to 1000°F	-312 to 1000°F

Indication range and Control range for thermocouple inputs other than the above:

Input range low limit value - 50°C (100°F) to Input range high limit value + 50°C (100°F)

### DC input

Indication range: [Scaling low limit value-Scaling span x 1%] to [Scaling high limit value-Scaling span x 10%]  
 However,  $\overline{\text{---}}$  or  $\overline{\text{---}}$  will flash if the range of -1999 to 9999 is exceeded.

Control range: [Scaling low limit value-Scaling span x 1%] to [Scaling high limit value-Scaling span x 10%]

**DC input disconnection:** When DC input is disconnected, PV/SV Display flashes  $\overline{\text{---}}$  for 4 to 20 mA DC and 1 to 5V DC inputs, and  $\overline{\text{---}}$  for 0 to 1 V DC input. For 0 to 20 mA DC, 0 to 5 V DC and 0 to 10 V DC inputs, the PV/SV Display indicates the value corresponding with 0 mA or 0 V input.

**[Power failure countermeasure]:** The setting data is backed up in the non-volatile IC memory.

**[Self-diagnosis]:** The CPU is monitored by a watchdog timer, and if an abnormal status occurs, the controller is switched to warm-up status, turning all outputs OFF.

### [Warm-up indication]

After the power supply to the instrument is turned on, the sensor input characters and temperature unit are indicated on the PV/SV Display for approx. 3 seconds.

### [Temporary PV/SV indication]

If the UP key is pressed in PV/SV Display mode, the opposite value to the value selected in [PV/SV indication] is indicated while the key is being pressed.

### Circuit insulation configuration

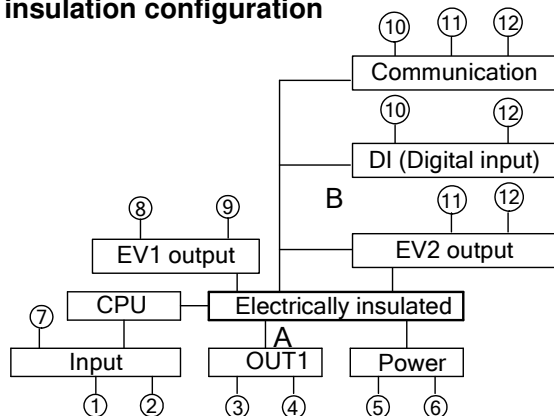

When OUT1 is non-contact voltage output or direct current output, A is not electrically insulated from B.

A: Terminals 3, 4

B: Terminals 10, 11, 12

**Insulation resistance:** 10 MΩ minimum, at 500 V DC

**Dielectric strength:** 1.5 kV AC for 1 minute between input terminal and power terminal  
 1.5 kV AC for 1 minute between output terminal and power terminal

**Supply voltage:** 100 to 240 V AC 50/60 Hz, 24 V AC/DC 50/60 Hz

**Allowable voltage fluctuation:** 100 to 240 V AC: 85 to 264 V AC, 24 V AC/DC: 20 to 28 V AC/DC

**Power consumption:** Approx. 5 VA

**Ambient temperature:** 0 to 50°C (32 to 122°F)

**Ambient humidity:** 35 to 85 %RH (non-condensing)

**Weight:** Approx. 91 g

**External dimensions:** 48 x 24 x 109 mm (W x H x D)

**Material, Color:** Material: Flame-resistant resin, Color: Light gray

**Drip-proof/Dust-proof:** IP66 for front panel

**Accessories included:** Instruction manual: 1 copy, Mounting frame: 1 piece  
 Terminal cover: 1 piece (when TC option is applied)

**Accessories sold separately:** Shunt resistor: 1 piece (50 Ω)

## 11.2 Optional Specifications

### Heating/Cooling control (OUT2) (Option code: DR)

OUT2: Relay contact 1a, Control capacity 3 A 250 V AC (resistive load),  
 1 A 250 V AC (inductive load  $\cos\phi=0.4$ )

OUT2 proportional band: 0.0 to 10.0 times (Multiplied value of OUT1 p-band) (ON/OFF action when set to 0.0)

OUT2 integral time: Same as that of integral time

OUT2 derivative time: Same as that of derivative time

OUT2 proportional cycle: 1 to 120 seconds

Overlap band/Dead band setting range:

TC, RTD input: -100.0 to 100.0°C (°F)

DC input: -1000 to 1000 (The placement of the decimal point follows the selection)

OUT2 ON/OFF hysteresis:

TC, RTD input: 0.1 to 100.0°C (°F)

DC input: 1 to 1000 (The placement of the decimal point follows the selection)

### Serial communication (Option code: C5)

The following operations can be conducted from an external computer.

(1) Reading and setting of SV, PID values and various set values

(2) Reading of the PV and action status (3) Function change

Cable length: Max.1.2km, Cable resistance: Within 50Ω (Terminator is not necessary or 120Ω or more on one side.)

Communication interface: EIA RS-485

Communication method : Half-duplex communication

Synchronization: Start-stop synchronization

Communication speed: 2400, 4800, 9600, 19200, 38400 bps (Selectable by keypad) (Default: 9600 bps)

Code form: ASCII, binary

Communication protocol: Shinko protocol (Default)/ Modbus ASCII/ Modbus RTU

In addition, each protocol above is available with Block Read/Write.

(Selectable by keypad)

Data format

Communication protocol	Shinko protocol	Modbus ASCII	Modbus RTU
Start bit	1	1	1
Data bit	7	7	8
Parity	Even	Selection (Even)	Selection (No parity)
Stop bit	1	Selection (1)	Selection (1)

Number of connectable units : Maximum 31 units to 1 host computer

Communication error correction: Command request repeat system

Communication error detection : Parity, checksum (Shinko protocol), LRC (Modbus ASCII), CRC-16 (Modbus RTU)

Digital external setting: Receives digital SV from Shinko programmable controllers (PCA1, PCB1 with C5 option)

**Color Black (Option code: BK):** Front panel frame, case: Black

**Terminal cover (Option code: TC):** Electrical shock protection terminal cover

## 12. Troubleshooting

If any malfunctions occur, refer to the following items after checking that power is being supplied to the controller.

### 12.1 Indication

Problem	Possible Cause and Solution
OFF is indicated on the PV/SV Display.	<ul style="list-style-type: none"> <li>Control output OFF function is working. To cancel the function, press the ① key for approx. 1 second.</li> </ul>
standby is indicated on the PV/SV Display.	<ul style="list-style-type: none"> <li>This is program standby status. If Program control function is selected in [OUT/OFF key function], and if SV is selected in [PV/SV indication], standby will be indicated in program standby. If PV is selected in [PV/SV indication], the PV will be indicated.</li> </ul>
---- is flashing on the PV/SV Display.	<ul style="list-style-type: none"> <li>Burnout of Thermocouple, RTD or disconnection of DC voltage (0 to 1 V DC): Replace each sensor. <b>How to check whether the sensor is burnt out</b> [Thermocouple] If the input terminals of the instrument are shorted, and if a value around room temperature is indicated, the instrument is likely to be operating normally, however, the sensor may be burnt out. [RTD] If approx. 100 Ω of resistance is connected to the input terminals between A-B of the instrument and between B-B is shorted, and if approximate 0°C (32°F) is indicated, the instrument is likely to be operating normally, however, the sensor may be burnt out. [DC voltage (0 to 1 V DC)] If the input terminals of the instrument are shorted, and if a scaling low limit value is indicated, the instrument is likely to be operating normally, however, the signal wire may be disconnected.</li> <li>Check whether the input terminals of thermocouple, RTD or DC voltage (0 to 1 V DC) are securely mounted to the instrument input terminals. Connect the sensor terminals to the instrument input terminals securely.</li> </ul>

**Indication**

Problem	Possible Cause and Solution
<p>[- - - -] is flashing on the PV/SV Display.</p>	<ul style="list-style-type: none"> <li>• Check whether input signal source for DC voltage (1 to 5 V DC) or direct current (4 to 20 mA DC) is disconnected.  <b>How to check whether the input signal wire is disconnected</b>                      [DC voltage (1 to 5 V DC)]                      If the input to the input terminals of the instrument is 1 V DC and if a scaling low limit value is indicated, the instrument is likely to be operating normally, however, the signal wire may be disconnected.</li> <li>[Direct current (4 to 20 mA DC)]                      If the input to the input terminals of the instrument is 4 mA DC and if a scaling low limit value is indicated, the instrument is likely to be operating normally, however, the signal wire may be disconnected.</li> <li>• Check whether input signal wire for DC voltage (1 to 5 V DC) or direct current (4 to 20 mA DC) is securely connected to the instrument input terminals.</li> <li>• Check if polarity of thermocouple or compensating lead wire is correct.</li> <li>• Check whether codes (A, B, B) of RTD agree with the instrument terminals. Wire them correctly.</li> </ul>
<p>The PV/SV Display keeps indicating the value set in [Scaling low limit].</p>	<ul style="list-style-type: none"> <li>• Check whether the input signal source for DC voltage (0 to 5 V DC, 0 to 10 V DC) and direct current (0 to 20 mA DC) is disconnected.  <b>How to check whether the input signal wire is disconnected</b>                      [DC voltage (0 to 5 V DC, 0 to 10 V DC)]                      If the input to the input terminal of this controller is 1 V DC, and if a value (converted value from scaling high, low limit setting) corresponding to 1 V DC is indicated, the controller is likely to be operating normally, however, the input signal wire may be disconnected.</li> <li>[Direct current (0 to 20 mA DC)]                      If the input to the input terminal of this controller is 4 mA DC, and if a value (converted value from scaling high, low limit setting) corresponding to 4 mA DC is indicated, the controller is likely to be operating normally, however, the input signal wire may be disconnected.</li> <li>• Check whether the input lead wire terminals for DC voltage (0 to 5 V DC, 0 to 10 V DC) or direct current (0 to 20 mA DC) are securely mounted to the instrument input terminals.</li> </ul>
<p>The indication of the PV/SV Display is irregular or unstable.</p>	<ul style="list-style-type: none"> <li>• Check whether sensor input or temperature unit (°C or °F) is correct. Select the sensor input and temperature unit (°C or °F) properly.</li> <li>• Sensor correction value is unsuitable. Set it to a suitable value.</li> <li>• AC leaks into the sensor circuit. Use an ungrounded type sensor.</li> <li>• There may be equipment that interferes with or makes noise near the controller.                      Keep the instrument clear of any potentially disruptive equipment.</li> </ul>
<p>Err 1 is indicated on the PV/SV Display.</p>	<ul style="list-style-type: none"> <li>• Internal memory is defective.                      Contact our agency or us.</li> </ul>

**12.2 Key Operation**

Problem	Possible Cause and Solution
<ul style="list-style-type: none"> <li>• Unable to set the SV1, P, I, D, proportional cycle or alarm value.</li> <li>• The values do not change by the <math>\Delta</math>, <math>\nabla</math> keys.</li> </ul>	<ul style="list-style-type: none"> <li>• Set value lock (Lock 1 or Lock 2) is designated.                      Release the lock designation.</li> <li>• Auto-tuning (AT) is performing.                      Cancel AT.</li> <li>• No alarm action, Timer function or Pattern end output has been selected in [A1 type] or [A2 type]. Select an alarm type.</li> </ul>
<p>SV2 cannot be set.</p>	<ul style="list-style-type: none"> <li>• SV1/SV2 external selection function has not been selected in [DI input function]. Select SV1/SV2 external selection function.                      Not available if C5 option is applied.</li> </ul>
<p>The setting indication does not change within the input range even if the <math>\Delta</math>, <math>\nabla</math> keys are pressed, and new values are unable to be set.</p>	<ul style="list-style-type: none"> <li>• Scaling high or low limit value in Auxiliary function setting mode 2 may be set at the point where the value does not change.                      Set it to a suitable value while in Auxiliary function setting mode 2.</li> </ul>

### 12.3 Control

Problem	Possible Cause and Solution
Temperature does not rise.	<ul style="list-style-type: none"> <li>• Sensor is out of order. Replace the sensor.</li> <li>• Check whether the sensor or actuator is securely mounted to the input or output terminals of the instrument. Ensure that the sensor or actuator is mounted to the instrument input or output terminals securely.</li> <li>• Check whether the wiring of sensor or actuator is correct.</li> </ul>
The control output remains ON status.	<ul style="list-style-type: none"> <li>• OUT1 low limit value in Auxiliary function setting mode 2 is set to 100% or higher. Set it to a suitable value.</li> </ul>
The control output remains OFF status.	<ul style="list-style-type: none"> <li>• OUT1 high limit value in Auxiliary function setting mode 2 is set to 0% or less. Set it to a suitable value.</li> </ul>
Program control ends soon even if it is performed.	<ul style="list-style-type: none"> <li>• Step time has been set to 00:00. Set the step time.</li> </ul>
Timer does not work.	<ul style="list-style-type: none"> <li>• Check whether the Delay action type or Timer delay time is set properly. Set it to a suitable value. Make a selection properly.</li> <li>• Check whether the Timer function is selected in [DI input function]. Select Timer function. If C5 option is applied, DI input function will not be available.</li> </ul>

For all other malfunctions, please contact our main office or dealers.

## 13. Character Table

Photocopiable material

[Main setting mode]

Indication	Setting Item	Factory Default	Data
14□□□	SV1 (Step 1 SV)	0°C	
171 AE	Step 1 time	00:00	
24□□□	SV2 (Step 2 SV)	0°C	
271 AE	Step 2 time	00:00	
34□□□	Step 3 SV	0°C	
371 AE	Step 3 time	00:00	
44□□□	Step 4 SV	0°C	
471 AE	Step 4 time	00:00	
54□□□	Step 5 SV	0°C	
571 AE	Step 5 time	00:00	
64□□□	Step 6 SV	0°C	
671 AE	Step 6 time	00:00	
74□□□	Step 7 SV	0°C	
771 AE	Step 7 time	00:00	
84□□□	Step 8 SV	0°C	
871 AE	Step 8 time	00:00	
94□□□	Step 9 SV	0°C	
971 AE	Step 9 time	00:00	

[Sub setting mode]

Indication	Setting Item	Factory Default	Data
AR□□□	AT	AT Cancel	
P□□□	OUT1 proportional band	2.5%	
P_b□□	OUT2 proportional band	1.0 times	
I□□□	Integral time	200 sec	
D□□□	Derivative time	50 sec	
AR□□□	ARW	50%	
C□□□	OUT1 proportional cycle	Relay contact: 30 sec Non-contact: 3 sec Direct current: Unavailable	
C_b□□	OUT2 proportional cycle	30 sec	
R4EF	Manual reset	0.0°C	
A1□□	A1 value	0°C	
A2□□	A2 value	0°C	

**[Auxiliary function setting mode 1]**

Indication	Setting Item	Factory Default	Data
PH	PV/SV indication	PV indication	
Lock	Set value lock	Unlock	
Cor	Sensor correction	0.0°C	
CanL	Communication protocol	Shinko protocol	
CanN	Instrument number	0	
CanP	Communication speed	9600 bps	
CanPr	Parity	Even	
CanSt	Stop bit	1	

**[Auxiliary function setting mode 2]**

Indication	Setting Item	Factory Default	Data
EnH	Input type	K: -200 to 1370°C	
FLH	Scaling high limit	1370°C	
FLL	Scaling low limit	-200°C	
dPt	Decimal point place	No decimal point	
FILT	PV filter time constant	0.0 sec	
oLH	OUT1 high limit	100%	
oLL	OUT1 low limit	0%	
HYS	OUT1 ON/OFF hysteresis	1.0°C	
E1L	EV1 output	A1 output	
E2L	EV2 output	A2 output	
db	Overlap band/Dead band	0.0°C	
HYSb	OUT2 ON/OFF hysteresis	1.0°C	
AL1F	A1 type	No alarm action	
AL2F	A2 type	No alarm action	
A1HY	A1 hysteresis	1.0°C	
A2HY	A2 hysteresis	1.0°C	
A1dY	A1 delay time	0 sec	
A2dY	A2 delay time	0 sec	
AHLd	Alarm HOLD function	Alarm Not holding	
dLYF	Delay action type	ON delay	
dLYT	Timer delay time	0 seconds	
CanF	Direct (Cooling)/Reverse (Heating) action	Reverse (Heating)	
AT_b	AT bias	20°C	
SV_b	SVTC bias	0°C	
Proc	OUT/OFF key function	Control output ON/OFF	
St_u	Step time unit	Hours:Minutes	
DI_fL	DI input function	SV1/SV2 external selection	
EqOff	Output status when input errors occur	Output OFF	
Func	Controller/Converter function	Controller	

**SHINKO TECHNOS CO., LTD.  
OVERSEAS DIVISION**

Head Office : 2-5-1, Senbahigashi, Minoo, Osaka, Japan

URL: <http://www.shinko-technos.co.jp/e/>

E-mail: [overseas@shinko-technos.co.jp](mailto:overseas@shinko-technos.co.jp)

Tel : +81-72-727-6100

Fax: +81-72-727-7006