

Instruction manual

## PS17 differential pressure transmitter



halstrup-walcher GmbH  
Stegener Straße 10  
79199 Kirchzarten

Tel. +49 7661 39 63-0  
[info@halstrup-walcher.com](mailto:info@halstrup-walcher.com)  
[www.halstrup-walcher.com](http://www.halstrup-walcher.com)

© **2019**

**08.04.19, Kö**  
**7100.006204 PS17 Instruction manual**

The manufacturer owns the copyright to this instruction manual. It contains technical data, instructions and drawings detailing the device's features and how to use them. It must not be copied either wholly or in part or made available to third parties.

The instruction manual is part of the product. Please read this manual carefully, follow our instructions, and pay special attention to the safety information provided. This instruction manual should be available at all times. Please contact the manufacturer if you do not understand any part of the instructions.

The manufacturer reserves the right to continue developing this device model without documenting such development in each individual case. The manufacturer will be happy to determine whether this manual is up-to-date.

# Table of Contents

- 1 Safety precautions .....4**
  - 1.1 Appropriate use ..... 4
  - 1.2 Warning symbols ..... 4
- 2 Storage and transportation .....4**
- 3 Disposal.....4**
- 4 Description of the device and its function.....5**
  - 4.1 PS17 differential pressure transmitter ..... 5
  - 4.2 Models..... 5
  - 4.3 Control units and dimensions..... 6
  - 4.4 Internal control units ..... 6
  - 4.5 Display (optional) ..... 7
- 5 Installing the device .....8**
  - 5.1 Mounting on a top-hat rail/dismantling ..... 8
  - 5.2 Wall mounting ..... 8
  - 5.3 Connecting the pressure ports ..... 9
- 6 Provide electrical connection ..... 10**
  - 6.1 Prepare supply voltage via cable glands ..... 10
  - 6.2 Prepare supply voltage via connectors..... 11
  - 6.3 Prepare relay connections ..... 11
- 7 Make Settings..... 13**
  - 7.1 Setting time constant ..... 13
  - 7.2 Zero-point calibration of measured values ..... 14
    - 7.2.1 Manual zero-point calibration ..... 14
    - 7.2.2 Zero-point calibration with voltage level..... 14
  - 7.3 Fine adjustment of the final value ..... 14
  - 7.4 Reset factory settings..... 15
  - 7.5 Configure output signal ..... 15
  - 7.6 Using the root-extracted output signal ..... 16
  - 7.7 Adjust the measurement range (optional)..... 17
  - 7.8 Set relay/switching threshold (optional) ..... 17
- 8 Technical data ..... 18**
- 9 Included in shipment..... 18**
- 10 Maintenance..... 18**
- 11 Troubleshooting ..... 19**
- 12 Declaration of Conformity ..... 20**

# 1 Safety precautions

## 1.1 Appropriate use

The PS17 differential pressure transmitter is designed to measure differential pressure in cleanrooms, machines, filter technology and heating, ventilation and air-conditioning systems (HVAC). It is used to measure the differential pressure of non-aggressive, non-combustible gases up to a pressure of 10 kPa in non-explosive environments.

Always observe the operating requirements indicated on the type label and the data sheet – particularly the permissible supply voltage.

The device may only be handled as indicated in this manual. Modifications to the device are prohibited. The manufacturer is not liable for damages caused by improper use or failure to follow these instructions. Violations of this type render all warranty claims null and void.

Repairs should only be carried out by the manufacturer. The device may only be cleaned from the outside with a damp cloth.

## 1.2 Warning symbols

The device has been designed and tested to ensure its safety. However, it may still be dangerous if used inappropriately. Precautions must be taken to prevent the device being used incorrectly by mistake. This device requires no maintenance. The device must be installed by trained technical personnel.

The following warnings are used in this instruction manual:

### **WARNING**

**This warns you of a potential hazard that could lead to serious bodily injury up to and including death if the corresponding instructions are not followed.**

# 2 Storage and transportation

Do not close the pressure inlets during shipping. Changes in barometric pressure may damage devices with low measurement ranges.

In addition, ensure that the device is stored at the correct temperature (see data sheet).

# 3 Disposal

The electronic components of the device contain environmentally hazardous materials and materials that can be reused. The device must therefore be sent to a recycling plant when you no longer wish to use it. Compliance with the environmental codes of your country is essential.

## 4 Description of the device and its function

### 4.1 PS17 differential pressure transmitter



The PS17 is a stationary differential pressure transmitter used for recording positive and negative differential pressures and converting them into electrical signals.

The device is designed for use in cleanrooms, machines, filter technology, and heating, ventilation and air-conditioning systems (HVAC). It is used to measure the differential pressure of non-aggressive, non-combustible gases up to a pressure of 10 kPa.

The device may only be used in the approved measurement range (see type label).

The piezoresistive pressure transmitter can be used to measure symmetrical or asymmetrical measurement ranges.

### 4.2 Models

The device is available in different models:

- With a fixed measurement range or toggling between 4 different measurement ranges
- 3 supply connection options:
  - a. 24 VAC / DC (with reverse polarity protection)
  - b. 15.. 32 VDC (2-wire)
  - c. 24 VAC (with galvanic separation)
- 3 electrical connection options:
  - a. 2 cable glands M16
  - b. 1 cable gland M20 (not for version with relay)
  - c. 1 connector M12 (not for version with relay)
- Optional: 3½ digit display
- Optional: Contact point/relay (not for 2-wire, cable gland M20 or connector M12).

The time constants and output signal are default settings (see type label). However, these settings can be configured.

Please also read the technical data provided in the data sheet:

<https://www.halstrup-walcher.de/en/products/all/PS17.php>

### 4.3 Control units and dimensions

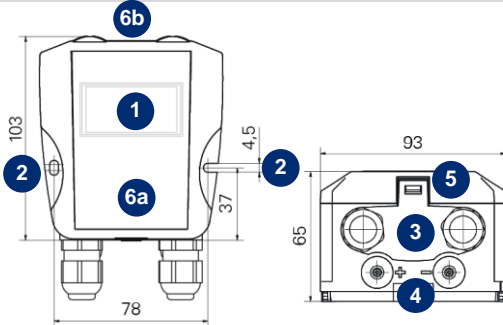

1. Display (optional)
2. Mounting option
  - Wall mounting with 2 screws
  - Top-hat rail mounting
3. Options for connection to the electrical power supply:
  - 2 cable glands M16
  - 1 cable gland M20
  - 1 connector M12
4. Hose connections 4 or 6 mm
5. Flap for opening the housing
6. Type label
  - a) Model without display
  - b) Model with display

### 4.4 Internal control units

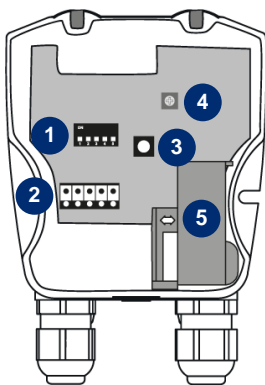

1. DIP switch
  - SW 1 and 2 set switchable measurement ranges (optional), otherwise no function
  - SW 3-5 set the output signal
2. Terminal
  - Connection to electrical power supply and output signal (connection diagram see label in the cover)
  - Zero-point calibration via signal input with +24 VDC
3. Key
  - Zero-point calibration
  - Fine adjustment of the final value
  - Restore factory settings
4. Potentiometer (with optional relay)
  - Set relay/switching threshold
5. Cover/connection for relay
  - Protective cover for possible 230 V connection

#### 4.5 Display (optional)

If your device has a display, the measurement range will be shown in Pa or kPa. The lower line of the display shows the number of the selected measurement range.

When a device is switched on, information is displayed in the following order:

1. program version
2. final value of the selected measurement range (for approx. 1.5 seconds)
3. measured values

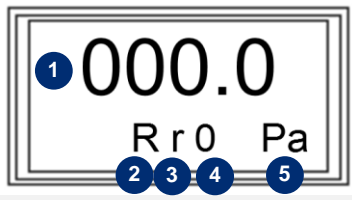
	<ol style="list-style-type: none"> <li>1 Output value (displays pressure in Pa and kPa, root-extracted signal in %)</li> <li>2 Number of the selected measurement range "R" (with optional switchable measurement ranges)</li> <li>3 Display "r" for root-extracted output signal</li> <li>4 Display "0" if zero-point calibration is in progress</li> <li>5 Units</li> </ol>
---	---

**Note:** At  $\pm 1999$  Pa, the display automatically switches to kPa. A choice between Pa and kPa is not provided for this unit.

## 5 Planning device attachment

You can mount the device on a top-hat rail or screw it to a wall.

Install the device with the pressure ports facing downwards so that any condensation in the hoses does not run into the sensor.

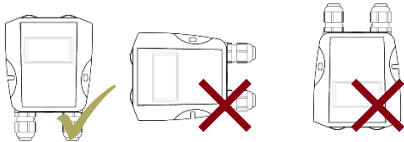

Avoid mounting the device close to any sources of heat or radiation (e.g. heaters, direct sunlight...) as this could result in measurement errors.

You can also use the STP file for planning, which you can download from our website:

<https://www.halstrup-walcher.de/en/products/all/PS17.php>

### 5.1 Mounting on a top-hat rail and dismantling

You can mount the device on a DIN rail (see assembly instructions).

- Please note the dimensions of the device when planning the installation (see drawing in chapter 4.3 Control units and dimensions).
- Ensure there is adequate space for the pressure and power supply ports under the device. Prevent the hoses from kinking in order to ensure stable measurements.

### 5.2 Screwing to the wall

You can fix the device to the wall using 2 screws (see assembly instructions).

- The drill holes must be prepared. The dimensions (78 mm) can also be found on the back of the device.
- The device has oblong holes for plumb alignment.



### 5.3 Planning the pressure connection

You can connect the pressure to the device using the pressure ports.

- Use hoses with a 4- or 6-mm inner diameter.
- When connecting the pressure, use the following table to ensure that the sign of the pressure (+ or -) is correctly connected.

Type of pressure	Connect pressure to	Example
Positive overpressure	+ Input port	0 .. 1 kPa
Negative overpressure	- Input port	0 .. - 500 Pa (output value positive)
Differential pressure (symmetrical/asymmetrical)	higher pressure at + port lower pressure at - port	0 .. 125 Pa e.g. via a primary element (e.g. a measuring orifice)  ± 200 Pa - 300 Pa .. + 1 kPa

- Do not allow hoses to kink or sag.
- Avoid accumulating moisture in the hose.
- If moisture can be produced in the hose or at the measurement location, the pressure sensor should be mounted above the measurement location. The hose must not sag between the sensor and the measurement location.
- Do not perform a function test with compressed or breathable air. This would damage devices with low measurement ranges.
- Please follow all the technical specifications relating to general conditions for applications in the data sheet at: <https://www.halstrup-walcher.de/en/products/all/PS17.php>

## 6 Provide electrical connection

The electrical power supply is connected via the cable glands at the bottom of the device or (optional) using an M12 connector.

The electricity supply may only be connected by trained professionals.

### 6.1 Prepare supply voltage via cable glands

For devices with cable glands, you can lead the cables through the housing to the terminals for the supply voltage (see assembly instructions).

- Ensure that the supply voltage is correct for your model
- Use cables with wire diameters of 0.25 .. 1.5 mm<sup>2</sup>
- Observe the connection diagram located in the housing cover
- The terminals are located at the bottom left of the circuit board (see chapter 4.4 Internal )
- Determine whether the digital zero-point calibration input is to be used and inform the installation technician
- Always observe the operating requirements indicated on the type label and in the data sheet – particularly the permissible supply voltage
- Provide the connections according to your desired supply voltage:

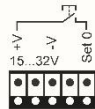
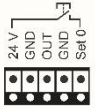
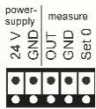
	<b>ZWL</b> <b>2-wire</b> 15 .. 32 VDC	<b>AC/DC</b> <b>3-/4-wire</b> 24 VAC/DC	<b>VDC</b> <b>4-wire with galvanic separation</b> 24 VDC
			
	<b>1 2 3 4 5</b>	<b>1 2 3 4 5</b>	<b>1 2 3 4 5</b>
<b>1</b>	+ connection	Inlet for supply voltage	Inlet for supply voltage
<b>2</b>	not assigned	Ground for supply voltage or output signal	Ground for supply voltage
<b>3</b>	- connection	Output signal (voltage/current)	Output signal (voltage/current)
<b>4</b>	not assigned	Ground for supply voltage or output signal	Ground for output signal
<b>5</b>	Zero-point calibration input +24V = active	Zero-point calibration input +24V = active	Zero-point calibration input +24V based on ground for output signal = active

**Outlook:** After switching on, the device requires a **warm-up time of approx. 15 minutes**

### Provide electrical connection

until the temperatures of the electronics and sensor have levelled off. The output signal may behave unstable during this time.

## 6.2 Prepare supply voltage via connectors

The device is also available with connectors (optional).

**Requirement:** To connect, please use a cable with a suitable female connector for the A-coded M12 connector.

Use the following pin assignment for the connector (external top view):

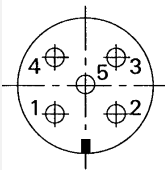
	ZWL 2-wire 15 .. 32 VDC	AC/DC 3-/4-wire 24 VAC/DC	VDC 4-wire with galvanic separation 24 VDC
	1 + connection	Inlet for supply voltage	Inlet for supply voltage
	2 not assigned	Ground for supply voltage or output signal	Ground for supply voltage
	3 - connection	Output signal (voltage/current)	Output signal (voltage/current)
	4 not assigned	Ground for supply voltage or output signal	Ground for output signal
	5 Zero-point calibration input +24V = active	Zero-point calibration input +24V = active	Zero-point calibration input +24V based on ground for output signal = active

## 6.3 Prepare relay connections

You can switch a 230 V voltage via the optional relay.

### WARNING

Inside the device there may be electrical conductors with a voltage of 230 V (relay option).

The device must be disconnected from the power supply and secured before opening!

The device may only be opened and connected to an electrical power source by qualified personnel.

You can connect the relay via the terminals in the device (see assembly instructions).

**Note:** No connector is provided for the relay connection. Two-wire devices cannot be supplied with relays.

**Note:** For high ambient temperatures > 60 ° C you must select suitable cables.

The manufacturer has provided the following safety features:

- Protective cover: the cover prevents the connecting cable from touching conducting parts if it slips/shakes (wrong connection). This protects the device and persons against contact with the 230 V supply in the event of a fault.
- Note on the circuit board: a warning symbol has been included on the circuit board as an additional measure.
- Observe the Low Voltage Directive: cables and strands for the voltages and currents used at the relay contact must be approved and connected in accordance with the applicable electrical codes for the application.



- |   |                      |                          |
|---|----------------------|--------------------------|
| 6 | Normally Closed (NC) | Opener (rest position)   |
| 7 | Common (COM)         | Middle position          |
| 8 | Normally Open (NO)   | Closer (active position) |



6 7 8

## 7 Make Settings

Open the cover carefully whenever you have to adjust the device settings (see assembly instructions).

### WARNING

**Inside the device there may be electrical conductors with a voltage of 230 V (relay option).**

**The device must be disconnected from the power supply and secured before opening!**

**The device may only be opened and connected to an electrical power source by qualified personnel.**

### 7.1 Setting time constant

You can adjust the smoothing of the measurement signal (Tau 63/Tau 90) by setting the time constant.

**Note:** The time constant is saved only for the current measurement range (optional switchable measurement ranges).

**Requirement:** For devices without an integrated display, you will require a display device to read the voltage signal 2 .. 10 V or current signal 4 .. 20 mA. If available, you can also use the optional display.

1. Disconnect the device from the power supply.
2. Keep the key pressed and switch on the device.  
On models with a display, the preset value is displayed in seconds (e.g. 0.025).
3. Switch between values (0.025 sec, 1 sec, 4 sec, 10 sec) by pressing the button several times until the desired value is displayed. To do this, read the value on the display or the display device:

Time constant/ device display	Output signal	Voltage signal 2 .. 10 V	Current signal 4 .. 20 mA
0.025 sec	0% of the hub	2 V	4 mA
1 sec	10 % of the hub	2.8 V	5.6 mA
4 sec	40 % of the hub	5.2 V	10.4 mA
10 sec	100% of the hub	10 V	20 mA

4. Confirm by pressing the key until the measured value is displayed again. For devices with display the firmware version is shown again, then the measured value appears.

The time constant is now configured.

## 7.2 Zeroing measured values

You can perform zero-point calibration for the measured values from the pressure transmitter. Use this setting option to ensure optimum differential pressure values and process reliability when large changes in temperature occur.

Zero-point calibration can be performed manually or with a voltage level.

**Note:** For models with an integrated display (optional), a “0” is displayed in the lower right corner of the screen during the zero-point calibration process (see chapter 4.5 Display (optional)).

### 7.2.1 Manual zero-point calibration

You can perform zero-point calibration of the device manually using the key (see chapter 4.4 Internal ).

**Requirements:** The supply voltage must be stable. The deviation from the zero-point must be less than 10%.

1. Make sure that there is no pressure on the device.
2. Press the key and keep it pressed for less than 10 seconds.
3. The zero-point calibration is complete after approx. 5-6 seconds.

The device is now zeroed.

**Note:** You can check that the zero-point calibration has been performed successfully by measuring the output voltage. For models with an integrated display (optional), you can read the measured value.

### 7.2.2 Zero-point calibration with voltage level

You can perform zero-point calibration of the device using the voltage level “Set0”.

**Note:** For devices with galvanic separation, you must connect a 24V signal to terminal 5 (Set 0) with reference to terminal 3 (GND).

1. Connect a 24 VDC voltage signal to the 5<sup>th</sup> connection on the terminal strip.
2. The zero-point calibration is performed for as long as the signal is applied. During this time the value at the output before the zero-point calibration is retained.
3. The zero-point calibration is complete after approx. 6 seconds.

The device is now zeroed.

## 7.3 Fine adjustment of the final value

You can fine-tune/correct the final value by up to 10% when pressure is applied.

1. Create a reference pressure on the device. This should exactly match the final value of your device.
2. Press the key briefly (< 10 sec.).

The final value is now adjusted.

## 7.4 Reset factory settings

You can reset the fine adjustment settings to the factory settings.

1. Turn on the device.
2. Hold down the key for at least 10 seconds.  
On devices with an integrated display (optional), the message “res” will be briefly displayed.

The fine adjustment settings are now restored to the factory settings.

## 7.5 Configure output signal

You can adjust the settings for the output signal.

**Note:** The two-wire version must be configured by the manufacturer (output signal always 4 .. 20 mA). Only the root-extracted signal settings can be adjusted.

**Requirements:** Open the housing (see assembly instructions). To make the setting, adjust the DIP switch SW 3-5 on the device. Use a non-conductive tool.

1. Disconnect the PS17 from the power supply.
2. Adjust the switches using the settings described in the table:

### Current signal I 0 .. 20 mA

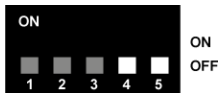

### 4 .. 20 mA



### Voltage signal U 0 .. 10 V

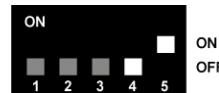

### 2 .. 10 V



### Linear



### Root-extracted



The output signal is now configured.

**Note:** On models with an integrated display (optional), the setting for the root-extracted output signal is displayed (see chapter 4.5 Display (optional)):

- root-extracted: “r”
- linear: (no “r”).

**7.6 Using the root-extracted output signal**

You can switch the output signal from linear to root-extracted. The linear measured value is converted into a root-equipped signal.

The output is displayed in % and calculated using the following function:

$$\text{Root-extracted signal} = \sqrt{\text{Measured value} / \text{Final value of measurement range}}$$

The value is displayed to one decimal point.

The following table explains the conversion using the example of 500 Pa as the final value of a measurement range:

Measured value	Linear signal	Conversion	Root-extracted signal
500 Pa	100%	$\sqrt{1} = 1$	100%
250 Pa	50%	$\sqrt{0.5} = 0.707$	70.7 %
100 Pa	20%	$\sqrt{0.2} = 0.447$	44.7 %
50 Pa	10 %	$\sqrt{0.1} = 0.316$	31.6 %

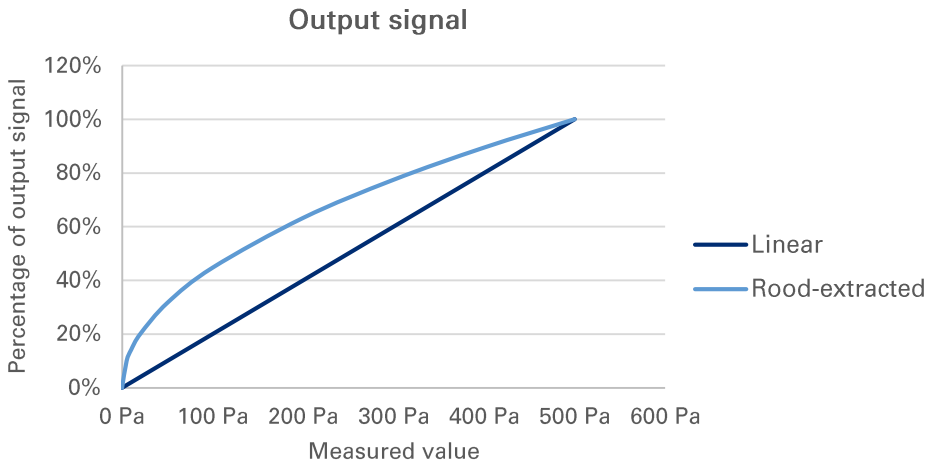



## 7.7 Adjust the measurement range (optional)

You can adjust the measurement range if the model features switchable measurement ranges.

- The final values of the device's measurement ranges are stated on the type label.
- The active measurement range settings are shown on the display (optional display), see chapter 4.5 Display (optional).

**Requirement:** Use a non-conductive tool.

1. Disconnect the PS17 from the power supply.
2. Open the housing (see assembly instructions).
3. To adjust the setting, use the DIP switches SW 1-2 on the device.
4. Adjust the switches using the settings described in the table:

**Measurement range R1**



**Measurement range R2**



**Measurement range R3**



**Measurement range R4**



5. Restart the device. The new settings will be applied after the device has been restarted. For devices with an integrated display, the final value for the selected measurement range will be displayed for approx. 1.5 seconds after the restart.
6. The measurement range is now set.
7. Perform the zero-point calibration for the device as described in 7.2 Zeroing measured values.

## 7.8 Set relay/switching threshold (optional)

For models with relays, you can also set the switching value.

**Requirement:** Use a non-conductive tool to adjust the potentiometer settings.

**Note:** The relay is connected to the sensor's output, so any adjusted time delays will also cause delays in the relay controls.

1. Set the pressure on the device at which the relay should switch.
2. Turn the potentiometer until the relay switches (metallic click) .
3. Adjust the potentiometer to this position (e.g. just before the relay switches).

The switching threshold for the relay is now set.

## 8 Technical data

Technical data and drawings can be found in the current data sheet on the website:  
<https://www.halstrup-walcher.de/en/products/all/PS17.php>

Please contact us if you require any further information.

## 9 Scope of delivery

The following parts are included in the scope of delivery:

1. PS17 differential pressure transmitter
2. Assembly instructions

## 10 Maintenance

This device requires no maintenance. Modifications to the device are prohibited.

# 11 Troubleshooting

You can eliminate malfunctions of the device by observing the following table.

**The qualified personnel responsible for the electrical connections must be notified if the device is damaged or if errors occur that cannot be corrected as indicated in this table.**

<b>Error description</b>	<b>Potential cause</b>	<b>Corrective action</b>
<b>No output signal</b>	Supply voltage is not connected	Connect the correct supply voltage
	Incorrect supply voltage is connected	Connect the correct supply voltage (see type label).
	Polarity reverse diode defective	Send the device to the manufacturer for repair
<b>Output signal is constant despite pressure change</b>	Output protection diode defective	Send the device to the manufacturer for repair
	Pressure ports reversed	Connect pressure in accordance with chapter 0 Planning the pressure connection
<b>Output signal incorrect</b>	Pressure sensor defective	Send the device to the manufacturer for repair
	Zero-point calibration with applied pressure	Perform zero-point calibration again without pressure
	Current output load too high	Observe maximum output load of 500Ω
	Load resistance resistance too low at voltage output	Observe minimum load resistance of 50 kΩ (see data sheet)
<b>Does not perform zero-point calibration</b>	Deviation from the zero-point is > 10% of the measurement range	Please contact our service department

## 12 Declaration of Conformity



### EU-Konformitätserklärung EU Declaration of Conformity Déclaration UE de Conformité

- Company** halstrup-walcher GmbH, Stegener Str. 10, 79199 Kirchzarten  
erklärt als Hersteller in alleiniger Verantwortung, dass das Produkt  
declares as manufacturer under sole responsibility, that the product  
déclare sous sa seule responsabilité en qualité de fabricant que le produit
- Product** Differenzdruck-Messumformer Typ  
Differential pressure transmitter type  
Transducteur pression différentielle type  
  
PS17 – x – x – x – x – x – x – x – x
- Regulations** den folgenden Europäischen Richtlinien entspricht:  
conforms to following European Directives:  
est conforme aux prescriptions des Directives Européennes suivantes:  
  
LVD 2014/35/EU  
EMC 2014/30/EU  
RoHS 2011/65/EU
- Standards** angewandte harmonisierte Normen:  
applied harmonized standards:  
norms harmonisées appliqués:  
  
EN 61010-1:2010  
EN 61326-1:2013  
EN 50581:2012
- Certification** EU Konformitätserklärung ausgestellt von  
EC Type Examination Certificate issued by  
Attestation d'examen CE de typ délivré par



Geschäftsführer Managing Director Président-Directeur Général  
Kirchzarten, 14. Mar 2019

# Notes





