



260Ex

Handheld Multichannel Reference Recorder

ADT260Ex Handheld Multichannel Reference Recorder

-----User Manual

[Version: 2211V01]

Additel Corporation

STATEMENT

This user manual provides operating and safety instructions for the ADT260Ex Handheld Multichannel Reference Recorder. To ensure correct operation and safety, please follow the instructions in this manual. Additel Corporation reserves the right to change the contents and other information contained in this manual without notice.

Content

Safety instructions	1
Special safety requirements	2
Intended use	6
1. Introduction	7
1.1 Product Overview.....	7
1.2 Technical specification	8
1.2.1 General specification.....	8
1.2.2 Signal measure specification (environmental temp.: 20±10°C, 1 year accuracy)	10
1.2.3 Simulate RTD measure accuracy (environmental temp.: 20±10°C)	11
1.3 Basic Structure.....	14
1.4 Standard package include.....	16
1.5 Power supply description	17
2.1 Main interface.....	19
2.1.1 Status bar.....	19
2.1.2 APPs list.....	19
2.1.3 Main function guide.....	20
2.2 Control center.....	21
2.2.1 Date and battery	21
2.2.2 Diagnostic center and screenshot.....	21
2.2.3 Shortcut settings	21



3. Data logger	22
3.1 Pressure Measurement.....	23
3.2 RTD measurement.....	25
3.3 Electrical signal measurement	26
3.3.1 DC Voltage measurement.....	26
3.3.2 Current measurement	26
3.3.3 Switch measurement	27
3.3.4 Pulse measurement.....	27
3.3.5 Frequency measurement	27
3.4 Filtering	28
3.5 Scaling	29
4. System settings	31
4.1 Bluetooth communication.....	31
4.2 Power management.....	31
4.3 System calibration.....	31
4.4 Services	32
4.4.1 Maintenance	32
4.4.2 Restore to factory.....	32
4.4.3 Running information.....	32
4.4.4 System upgrade.....	32
4.5 Personalization.....	33
4.5.1 Sound	33

4.5.2 Language	33
4.5.3 Date & Time	33
4.6 Product information	34
5. Data management	35
6. Data logger	36
6.1 Display mode	36
6.1.1 Single-channel mode	36
6.1.2 Multi-channel list mode	38
6.2 Channel data	39
6.3 Channel curve	39
6.3.1 Following Mode	39
6.3.2 Eye pattern mode	39
6.4 Save the data	39
7. Applications	40
7.1 Differential pressure module	40
7.2 Units converter	41
7.3 Wiring help	41
7.4 Leak test	41
7.4.1 Leak Test Performing	42
7.5 PSV test	43
7.5.1 PSV test performing	43
7.6 Sensor library	44

Figure Content

Figure 1 Basic Structure.....	14
Figure 2 Adaptor and the power plug	17
Figure 3 Main interface.....	18
Figure 4 Control center.....	20
Figure 5 Calibrator main screen	23
Figure 6 RTD measurement.....	25
Figure 7 Voltage/ frequency/ pulse/ switch wiring.....	26
Figure 8 Current measurement	27
Figure 9 Filter settings.....	28
Figure 10 Scaling configurations	30
Figure 11 Single-channel mode.....	37
Figure 12 Multi-channel list mode	38

Safety instructions

Warning:

To prevent the user from injury, please follow this user manual for use.

To prevent fire, electric shock, or personal injury, please do as follows:

Normal:

- ◆ Please read the user manual before using the product, especially the Safety Instructions;
- ◆ Please charge the battery when a low battery level is displayed in case of the measurement abnormal;
- ◆ Do not expose the battery to fire or short circuit the battery;
- ◆ Before using the product, please check the appearance of the product for any damage;
- ◆ If the product is damaged or malfunctions, do not use it, and contact Additel;
- ◆ Do not touch the metal part of the probes or test cables during use;
- ◆ Please remove unnecessary probe, cable, or other accessories before using the product;
- ◆ Do not use damaged or worn cable.

Attention:

To prevent damage this product or the device under tested, please obey the instruction manual for use

- ◆ Do not use the instrument in a high vibration environment;
- ◆ Use only the Additel power adaptor and designated battery models;
- ◆ In case of working with external pressure module, refer to the Safety instructions of its manual.



Special safety requirements

1. WARNING – DO NOT OPEN WHEN AN EXPLOSIVE ATMOSPHERE IS PRESENT
2. WARNING – DO NOT CHARGE THE BATTERY IN HAZARDOUS LOCATION
3. WARNING – USE ONLY the approved batteries, see Ex instruction
4. The equipment should be protected from high energy impacts
5. Do not touch the non-metallic enclosure or touch with the insulating materials only
6. The batteries used in the equipment should be the same manufacturer, model and electrochemical system
7. The conformal coating applied to PCB boards was declared meet the requirements of IEC 60664-1 and IEC 60664-3 by manufacturer
8. Tamb: -20°C to +50°C
9. USB port should only be used in Non-hazardous areas.
10. PX connections to be made with pressure measuring module CDPX-Ex only, the connected cables and flexible hose used for the external pressure modules are made of insulation materials, so end user should consider the risk of electrostatic discharge during material selection and installation process
11. Metallic parts (only fasteners) presented a maximum capacitance of total 110pF, end user should consider this risk for suitable applications
12. No additional input energy limitation are required for Type-C USB port and DC charging port when Um does not exceed 250V (internal OVP/OCP are designed in line with IEC 60079-11)

13. Do not remove the silicone rubber protective sleeve from the enclosure of equipment in Hazardous area

14. IS parameters must be observed for different external measuring ports on the different models in accordance with Ex instruction strictly and completely

15. Intrinsically safe electrical system between IS apparatus and Associated apparatus or other IS apparatus:

Item	I.S Interface	External Measuring Instrument	System
Equipment group	IIC	IIC	IIC
Level of protection	ia	ia	ia
Temperature class	T4	T4	T4
Ambient temperature	-20°C~+50°C	-20°C~+50°C	
Voltage	Uo	Ui(30V)	
Current	Io	Ii(100mA)	
Power	Po	Pi(0.75W)	
Cable parameters			
Capacitance	Co	Ci	Cc
Inductance	Lo	Li	Lc
L/R ratio	/	/	/
Grounding	Isolated	Isolated	Isolated

$$U_o \leq U_i$$

$$I_o \leq I_i$$

$P_o \leq P_i$

$C_o \geq C_i + C_c$

$L_o \geq L_i + L_c$

Standard Compliance

- EN IEC 60079-0:2018
- EN 60079-11:2012
- IEC 60079-0:2017 Edition 7.0
- IEC 60079-11:2011 Edition 6.0

Ex information for equipment name

- National regulations: ATEX directive 2014/34/EU and IECEx scheme 02
- Certificate No.: TÜV 20 ATEX 8509 X and IECEx TUR 20.0009X
- Ex Marking for EU-Type Examination:  II 1 G Ex ia IIC T4 Ga
- Ex Marking for IECEx CoC: Ex ia IIC T4 Ga
- Ex Marking for UKCA certificate: CSAE 22UKEX1201
- Tamb: -20°C~+50°C
- IP Rating: IP20
- I.S Parameters:

Additel 260Ex Handheld Multichannel Reference Recorder

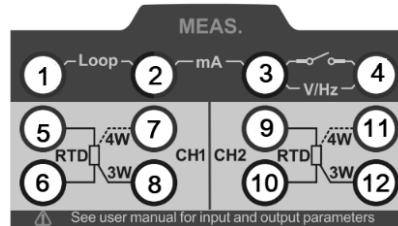

Input parameters, simple connection

Connection	Function	Ui/V	Ii/mA	Pi/mW	Ci/nF	Li/mH
J1, J3	HART (external power and external resistance)	30	100	750	10	0
J2, J3	Current measurement	30	100	750	1	0
J4, J3	Voltage, frequency, and switch measurement	30	100	750	1	0
J1, J2	Loop Circuit Transmitter Current Measuring / HART (Internal Power and Resistance)	30	100	750	10	0
J5-J8 J9-J12	Resistance measuring	30	100	750	20	0



Output parameters, simple connection

Connection	Function	Uo/V	Io/mA	Po/mW	Co/ μ F	Lo/mH
J1, J3	HART (external power and external resistance)	25.2	79.16	499	0.107	9
J2, J3	Current measurement	5	0.85	1.1	87	100
J4, J3	Voltage, frequency, and switch measurement	5	0.85	1.1	87	100
J1, J2	Loop Circuit Transmitter Current Measuring / HART (Internal Power and Resistance)	25.2	79.16	499	0.107	9
J5-J8 J9-J12	Resistance measuring	5	21	26.3	85	30

Intended use

- The equipment to be used in Zone 0 hazardous area with gas group IIC.
- The equipment is used in oil and gas platforms, oil refineries, chemical and petrochemical plants, pharmaceutical industry, energy and gas processing industries.

1. Introduction

1.1 Product Overview

ADT260EX is an intrinsically safe pressure and temperature logger provided by Additel. It can be used in zone 0 environment and has an 8-channel combination capability, supports measurement and logging of pressure, temperature, barometric pressure and electrical signals. It can keep 10 million records, display the trend curve, and support Bluetooth communication. Powerful logging capability and high-level intrinsically safe make it widely used in ex-proof pipeline field /container pressure test, air leak test, inlet and outlet pressure test of pump station, safety valve and ex-proof membrane test, wellhead pressure test, pipeline filter test, differential pressure transmitter/flow computing test, as well as used in the routine calibration of pressure devices.

How to contact us

TEL: 1-714-998-6899

Or visit Additel website: www.additel.com



1.2 Technical specification

1.2.1 General specification

Table 1 General specification

General Specification	
Input Channel	Top: 2 channels RTD measurement, 1 channel electric signal measurement, ϕ 4mm banana jacks
	Right side: 2 channels for external digital pressure module, Lemo style connection
	Bottom: embedded digital pressure module (model ADT158Ex) field switchable.
	Internal: 1 embedded atmospheric pressure sensor
Barometric Accuracy	± 55 Pa
Measurement Rate	mV, V, mA & frequency and RTD: 3 times/ sec
	Pressure module: 1~10 times/sec selectable (3 as default)
	Barometric: 1 times/ sec
Data Storage	Logging interval: from 0.1~9999 seconds, log up to 10 million readings (single channel)
Power	4000mAh, 14.4Wh explosion-proof intelligent lithium battery, charging time is 6~8 hours, the battery can be charged independently Typical working time 100 hours (measurement mode)
Environmental	Guaranteed temperature range of technical specifications: (-10 ~ 50) $^{\circ}$ C *Temperature coefficient: ± 5 ppm FS/ $^{\circ}$ C (-20 to -10) $^{\circ}$ C

	Operating temperature: (-20 ~ 50)°C
	Storage temperature range: (-30 ~ 70)°C
	Humidity: 0% to 95% RH, non-condensing
	Altitude: 3000 meters
Warm Up Time	10 minutes to fully meet technical specifications
Port Protection Voltage	30V max
Explosion-proof Grade	ATEX & IECEX: Ex ia IIC T4 Ga (Ta = -20°C to +50°C)
	CSA: Class I, Division 1, Group A,B,C and D, T4 Class I, Zone 0, AEx ia IIC T4 Ga Ta = -20°C to + 50°C Ex ia IIC T4 Ga
	UKCA-EX
CE Certification	TUV IEC61326, IEC61010
Rohs Compliance	Rohs II Directive 2011/65/EU, EN50581:2012
Protection Level	IP67, 1 meter drop test
Communication	Isolate USB-TYPEC (slave), Bluetooth
Display	4.4-inch color display capacitive screen, transfective, with LED backlight
Size	6.97" x 4.13" x 2.04" (177 mm x 105 mm x 52 mm) which does not include the bottom mount ADT158Ex if installed.
Weight	1.65 lb. (0.75 kg)
Warranty Time	1 year



1.2.2 Signal measure specification (environmental temp.: 20±10°C, 1 year accuracy)

Table 2 Signal measure specification

Specification	Range	Accuracy	Resolution	Note
RTD Measurement Accuracy	0~400Ω	0.01%RDG+0.005%FS ^[1]	1mΩ	Excitation current: 1 mA
Voltage Measurement	±300mV	0.015%RDG + 0.005%FS	1uV	Impedance: >100MΩ
	±30V	0.015%RDG + 0.005%FS	0.1mV	Impedance: >1MΩ
Current Measurement	±30mA	0.015%RDG + 0.005%FS	0.1 uA	Impedance: < 40Ω
Frequency Measurement	0.01~50000Hz (auto range)	0.005% RDG + 2 last digit	6-digit auto-resolution	Min threshold voltage: 2.5V
Switch On-Off Measurement	Inspection voltage: (3 ~ 30)V Response speed: < 10ms, supports wet and dry switch			
Pulse Count	0 ~ 9999999, optional rising edge and falling edge Min threshold voltage: 2.5V			
Loop Power	20V ± 10%, max output impedance: 320Ω, max load current: 25mA			

Note 1: When the environmental temperature is (-20~-10) °C, the temperature coefficient is:

(1) Measure of voltage, current and RTD: ±5ppmFS/°C.

Note 2: Input characteristics:

(1) Voltage range: -300~300mV input impedance >100 MΩ;

(2) Voltage range: -30~30V input impedance >1M Ω ;

(3) Current measure: input impedance <40 Ω ;

Note 3: The excitation power supply for RTD measure is 0.2mA, and each position has 4-wire, 3-wire, and 2-wire methods. The accuracy is as follows: (given accuracy data in the table in based on 4-wire)

(1) The accuracy of the 3-wire method is 10m Ω more than the accuracy of the 4-wire method;

(2) The accuracy of the 2-wire method is 50m Ω more than the accuracy of the 4-wire method.

Note 4: Minimum threshold voltage for frequency and pulse measure: 2.5V;

Note 5: The frequency measure supports following units: Hz, kHz, MHz, CPM, CPH, s, ms, μ s

Note 6: There are rising edge and falling edge trigger mode available for pulse measure.

1.2.3 Simulate RTD measure accuracy (environmental temp.: 20 \pm 10 $^{\circ}$ C)

Table 3 Simulate RTD measure accuracy

Sensor type	Temperature($^{\circ}$ C)	Annual accuracy($^{\circ}$ C)	
PT10(385)	-200~850	-200~200	0.59
		200~600	0.72
		600~850	0.82
PT25(385)	-200~850	-200~200	0.27
		200~600	0.35



		600~850	0.41
PT50(385)	-200~850	-200~200	0.16
		200~600	0.22
		600~850	0.27
PT100(385) PT100(391) PT100(3916) PT100(3926)	-200~850	-200~200	0.10
		200~600	0.16
		600~850	0.20
PT200(385)	-200~850	-200~200	0.32
		200~300	0.34
		300~600	0.41
		600~850	0.48
PT400(385)	-200~850	-200~0	0.15
		0~200	0.18
		200~600	0.25
		600~850	0.30
PT500(385)	-200~850	-200~200	0.16
		200~600	0.22
		600~850	0.27
PT1000(385)	-200~850	-200~200	0.10

		200~600	0.16
		600~850	0.20
Cu10(427)	-200~260	-200~260	0.56
Cu50(428)	-50~150	-50~150	0.13
Cu100(428)	-50~150	-50~150	0.08
Ni100(617) Ni100(618)	-60~180	-60~0	0.06
		0~180	0.05
Ni120 (672)	-80~260	-80~260	0.05
Ni1000	-50~150	-50~150	0.07

Note: It complies with the international temperature scale ITS90, depends on the maximum tolerance of the RTD measurement and simulate signal output.

1.3 Basic Structure

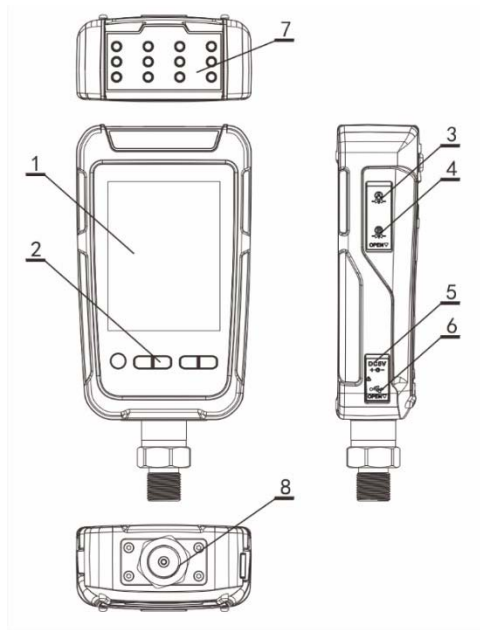

Figure 1 Basic Structure

Table 4 Basic Structure

Subject	Content	Description
1	Display+ capacitive touch screen	Display area, touchable
2	Keys	For operating the device
3	Lemo port A	Connect to external pressure module.
4	Lemo port B	Connect to external pressure module.
5	Adaptor port	Power supply from adaptor.
6	USB slave port	For USB communication.
7	Electric test plug	Connection for electric test, including cables and HART communication.
8	Pressure module	For pressure measure



1.4 Standard package include

Table 5 Accessories

Accessories		
Included	Test leads	5 sets(10pcs)
	Ex-proof USB Cable type A to type C (For Ex models only)	1 pc
	110V/220V external power adaptor	1 pc
	Chargeable Li-ion battery	1 pc
	Hanging strap with magnet	1 pc
	ISO 17025 accredited calibration certificate	1 pc
Optional	ADT158Ex Built-in digital pressure module	
	ADT161Ex External digital pressure module	
	9530 Additel/ACal calibration software	
	9060 Pressure module connection cable	
	9905 Hard carrying case for handheld calibrators and readouts with space for two RTDs	
	9918-SC Soft carrying case, with space for handheld instrument, test leads, and accessories	

Note: in case of changes on the accessories list, please refer to the packing list in shipping.

1.5 Power supply description

(1) By Ex-proof Li-ion battery

Supply the power by 1 pc BP3640Ex Ex-Proof Intelligent Li-ion battery.

- Ex-Proof Li-ion battery is chargeable by external power independently.
- The power adaptor is adaptable for standard in various countries.
- Do not expose the battery to fire or short circuit the battery.
- Use only the Additel power adaptor and designated battery models.



Figure 2 Adaptor and the power plug

2. Overview for display and basic functions

The ADT260Ex will automatically go to Data Logger function after powered on. It can also be returned to main interface for all the functions. (Refer to Figure.3).

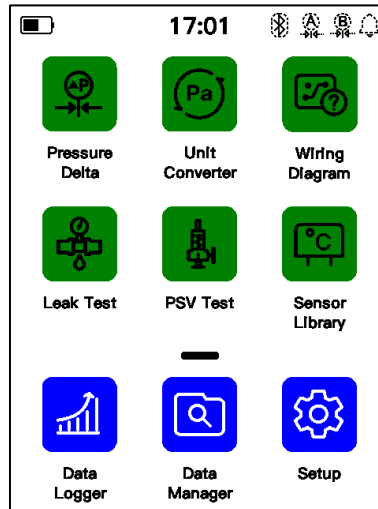













Figure 3 Main interface

2.1 Main interface

In the main interface, there are three sections from top to bottom: status bar, APPs list and main function guide, as shown in Figure 3.

2.1.1 Status bar

On the top of the main interface shows the status information, including:

1. System time: real-time of the system;
2. Battery: real-time display the battery level and charging status. Icon  indicates the adaptor is connected.
3. Bluetooth: icon  indicates Bluetooth function is on, while icon  indicates off;
4. Module A: icon  indicates the external module A is connected, while  indicates not connected;
5. Module B: icon  indicates the external module B is connected, while  indicates not connected;
6. Message center: icon  flashes means there is message, warning or abnormal, icon  means no message;
7. 24V status: icon  indicates 24V power supply is on, icon  disappears indicates the 24V power supply is off;
8. Screen lock: icon  means the screen is locked.

2.1.2 APPs list

The APPs list shows all the applications provided in the device, including differential pressure module, unit converter, wiring help, leak test, PSV test and sensor library. Click the button , or use the left and right key to switch between interfaces of the APPs list.

2.1.3 Main function guide

The main function guide at the bottom of the interface provides access to three main functions of the device: data logger, data manager and setup.

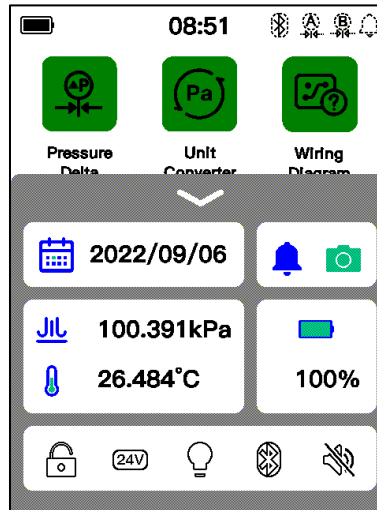



Figure 4 Control center



2.2 Control center

In any interface of the device, the control center (Figure 4 Control Center) can be called up by physical key . It provides detailed information of date, battery, diagnostic center, screenshot functions, and some shortcuts items.

2.2.1 Date and battery





In the control center show the current date and precise battery percentage.

2.2.2 Diagnostic center and screenshot

Click icon  in the control center to open the diagnostic center, which shows the real-time diagnostic hardware status of the device. If some of the function fails, check the cause here, as in Figure 5. Click icon  in the diagnostic center to see the historic abnormal log. Click  icon to take the snapshot, which can be viewed or deleted in data manager APP.



2.2.3 Shortcut settings

The control center provides series of shortcut settings:

1. Click icon  to lock the screen, any touch operation and physical keys except the control center and power are invalid during lock.
2. Click icon  to open and close 24V loop power supply.
3. Click icon  to open and close the backlight.
4. Click icon  to open and close Bluetooth.
5. Click icon  to enable and disable system sound.

3. Data logger

The ADT260Ex can be used for measuring and recording many signal types, including the signal of the internal pressure module, external pressure module A and B, differential pressure module, barometric pressure, 2-wire RTD and electrical signal measurement, totally 8 measurement features available. The electrical signal measurement supports voltage, current, switch, pulse, and frequency. On the main page, there can be up to 6 measuring items display at the same time.

On the middle of the channel there is the current measured signal of this channel. The icon of the signal type and the corresponding range information is displayed on the upper left; Click the icon  in the upper right corner to set the current channel in the pop-up menu; Click the icon  in the lower right corner to perform the zero on the current channel. If the signal type selected in the channel has multiple values for display (for example, after enabling the scaling, it shows concurrently the scaled value and initial value), the channel will also display these signal values below the main signal value. In case of too many channels displayed on the main page, the device will automatically simplify the content to fit the screen.





















	16:16	   
	Datalogger	
	12.11 kPa	
	-0.05 kPa	
	7.75 kPa	
	-7.802 kPa	
	27.545 Ω	
	0.0000 v	

Figure 5 Calibrator main screen

3.1 Pressure Measurement

The device can measure the pressure by internal pressure module, external pressure module A/B, differential pressure, and barometer. The external pressure A  and B  are only available when the external pressure module is connected. The differential pressure function is available when it is enabled in the “Pressure Delta ” APP and both the

two modules are online. Select the proper module in the Channel settings to measure the pressure. Click the pressure unit above the pressure measurement value to switch the pressure unit in the pop-up unit selection interface. Click the menu icon  in the pressure measurement channel and click the "Settings" menu in the pop-up menu to set the pressure type, resolution, stability, tare, and other functions of the current pressure measurement channel.

Table 6 Pressure measurement settings

Subject	Valid Value	Description
Resolution	4/5/6	Resolution of current measurement channel
Pressure type	GP/ AP	Current measurement channel pressure type
Measurement frequency	1~10Hz	Data acquisition frequency of the current measurement channel
Stability enable	Enable/disable	Whether to turn on the stability judgment function
Stability value	Pressure value or percentage of range	A value for judging whether the pressure is stable. If the measured value fluctuates less than this value within the stable time, the calibrator will judge as stable
Stabilization time	Number	Time to judge the pressure stability
Tare enable	Enable/disable	Enable or disable tare function
Tare value	Pressure value	Correction value of the tare function

3.2 RTD measurement

The connection of RTD measurement is shown in figure 6. Click the switching menu and select the RTD measurement

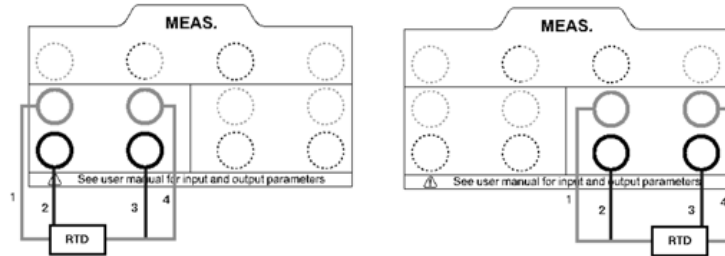

Figure 6 RTD measurement

Click the "Settings" of the RTD measurement channel to set various parameters for the functions.

Table 7 RTD settings

Subject	Valid Value	Description
Sensor type	RTD	Select the type of thermal resistance sensor
Wires	2/3/4	Select the RTD wire
Temperature unit	K / °F/ °C	Temperature unit selection
Resolution	0~0.001	Temperature display resolution

3.3 Electrical signal measurement

3.3.1 DC Voltage measurement

Please connect correctly as shown in the figure 7. Then switch the measurement signal to voltage measurement. To ensure measurement accuracy and adapt to more usage scenarios, two different ranges can be selected for voltage measurement in this device: $(-30\sim30)V$ and $(-300\sim300)mV$, the user should select the appropriate measurement item according to the use situation.

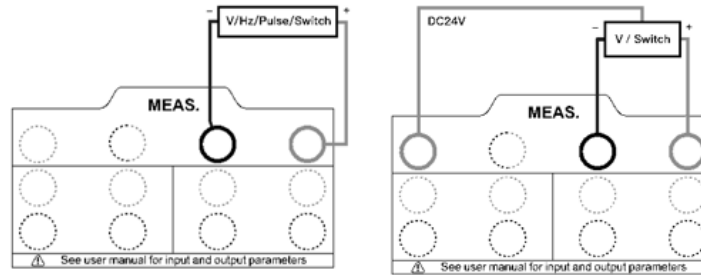

Figure 7 Voltage/ frequency/ pulse/ switch wiring

3.3.2 Current measurement

Please connect correctly as shown in the figure 8. Then switch the measurement signal to current measurement ($-30\sim30$)mA .

3.3.3 Switch measurement

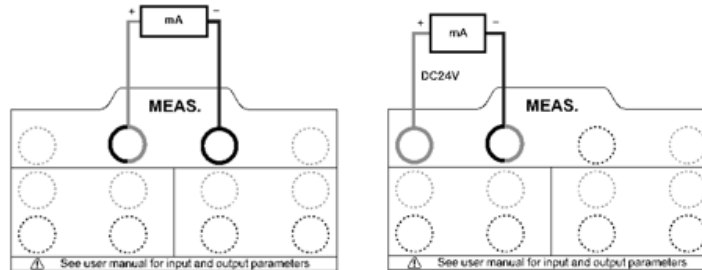



Figure 8 Current measurement

The wiring method of the switch measurement function is the same as the voltage measurement. After wiring, please switch the measurement signal channel to switch measurement .

3.3.4 Pulse measurement

The wiring method of the pulse measurement function is the same as the voltage measurement. After wiring, please switch the measurement signal channel to (0 ~9999999) . Pulse measurement allows the user to set the pulse counting method. In the pulse measurement mode, enter the setting menu to select whether the pulse counting uses rising or falling edges for counting.

3.3.5 Frequency measurement

The wiring of the frequency measurement function is the same as the voltage measurement. After wiring, please

switch the measurement signal channel to frequency measurement (0.01~50k)Hz .

3.4 Filtering

The ADT260Ex provides two filtering methods: first-order linear filtering and moving average filtering to process data to meet the needs of different scenarios. Click the menu button  of the measurement channel, select the filter menu item in the pop-up menu, and the filter setting interface will be displayed (see Figure 9).

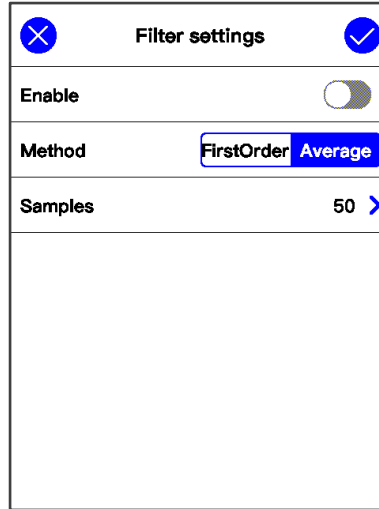

Figure 9 Filter settings

Table 8 Filter configurations

Subject	Valid Value	Description
Enable/disable	Enable/disable	Enable or disable the filter function
Method	first-order linear filter or moving average filter	Filtering method
Filter coefficient	0 ~ 1	Only available when the first-order linear filter is selected
Number of samples	1~50	Only available when the moving average filter is selected

3.5 Scaling

The scaling function can convert electrical signals into other signals. Click the menu button  of the measurement channel, select the scaling menu item in the pop-up menu, and the parameter configurations related to scaling will be displayed (see Figure 10).

Table 9 Scaling configurations

Subject	Valid Value	Description
Enable/disable	Enable/disable	Enable or disable the scaling function
Input range	Number	Range before scaling
Output range	Number	Range after scaling
Resolution	0~0.000001	The number of decimal places displayed after scaling
Transfer function	Linear, square, or square root	Scaling transfer function

Scaling	
Enable	<input type="checkbox"/>
Initial Range	(-30 ~ 30) V >
Scaled Range	(0 ~ 100) kPa >
Resolution	0.0001 >
Transfer function	Linear >

Figure 10 Scaling configurations

4. System settings

On the main page of the device, click the system setting button  in the middle of the bottom to enter the system setting interface. System maintenance, system calibration, and various basic system settings are provided in the system settings.

4.1 Bluetooth communication

The device has the function of Bluetooth communication. Click the "Bluetooth Communication" menu item in the system setting interface to enter the Bluetooth communication setting interface. The Bluetooth communication setting interface provides the enabling and disabling of the Bluetooth communication function and the query function of the Bluetooth device name and physical address.

4.2 Power management

Click the "Power Management" menu item in the system setting interface to enter the power management interface. In the power management interface, the user can enable and disable the screen backlight, set the time for automatically turning off the backlight, automatic standby, and automatic shutdown.

4.3 System calibration

Click "System Calibration" in the system setting interface and enter the calibration password "123456" in the pop-up password input box to enter the system calibration interface. In the system calibration interface, you can calibrate all the measurement and output signal in the device. The calibration process is as follows:

1. Select the item to be calibrated in the signal list.



-
2. Use a high-precision standard device, after fully warming up, follow the calibration guide in the interface and click the "Start" button to start the calibration.
 3. According to the reference calibration point provided on the interface, select the appropriate standard value, and enter it.
 4. Click the "Finish" button to send the calibration data to the module to complete the calibration.

Click the "Restore" button at the bottom of the calibration interface to restore to the factory calibration data of the device. Click the "Cancel zero" button to clear the zeroed data of the current signal.

4.4 Services

4.4.1 Maintenance

This function is only open for manufacturer.

4.4.2 Restore to factory

Enter the password for this function, default password is 123456.

- ◆ Restore to the factory default settings, will not restore the system calibration data.

4.4.3 Running information

To view the device running information. It includes the barometric reading, current battery voltage and electric module information.

4.4.4 System upgrade

Users can upgrade the device firmware via the USB-C.

4.5 Personalization

Click the "Personalization" menu item in the system setting interface to enter the personalized setting interface. In the personalized setting interface, users can set the device's sound, language type, current time, and date, and time date format according to their own preferences.

4.5.1 Sound

Change the sound level by adjusting the volume bar. It also provides sound configuration, as in Table 10.

Table 10 Sound settings

Subject	Valid Value	Comment
Sound enable	On / Off	Sound enable setting
Prompt sound	On / Off	Prompt sound setting
Touch sound	On / Off	Touch sound setting
Over range sound	On / Off	Over range sound setting
Alarm sound	On / Off	Alarm sound setting

4.5.2 Language

The device provides a multi-language user interface. Use this menu to change from the provided languages.

◆ After the language is selected, the device needs to be restarted for the changes to take effect.

4.5.3 Date & Time

The device provides customizable settings for time and date, as shown in Table 11.

Table 11 Date & time

Subject	Valid Value	Comment
Date	2000-1-1 ~ 2099-12-31	Date setting
Time	00:00 ~ 23:59	Time setting
Date format	Y-M-D / M-D-Y / D-M-Y	Date format setting
Separator	-, /, .	Date separator setting
24 hours	enable	24-hour or 12-hour format

4.6 Product information

Product information is read-only information, includes basic information and the module information.

- ◆ Basic information: including model, serial number and system version information.
- ◆ Module information: including EM board version, ES board version and TMS board version.
- ◆ External module information: including external module A and external module B.

5. Data management

On the main page of the device, click the file management button  in the middle bottom to enter the data management interface. The file management interface is classified and managed by functional modules, and the data saved by each function is managed in the corresponding folder, which is convenient for users to browse.

The functional modules that can save data files are: snapshot, data logger, PSV test and leak test. In the corresponding folder, the users can open the operation menu through the menu button  in the upper right corner and delete and batch delete the files in it.

6. Data logger

The most important function of the device is the data logger. Click the menu icon  at the top right of the main interface and click "Start logging" to enter the logging configuration interface. Here it is available to set the interval for each logging point and the total number & time of loggings. After finishing the configuration, click OK to start.

During the process, the measured values of all currently selected channels and the time are recorded and saved in a file. After the logging starts, the progress bar at the bottom and the percentage will show the progress, and the time beside the progress bar will show the remaining time.

Click the stop icon  on the upper right to terminate the current logging, and you can choose whether to store the data that has been recorded during the process.

6.1 Display mode

The ADT260Ex supports single-channel mode and multi-channel list mode, click the icon  at the left of the progress bar to switch the display mode.

6.1.1 Single-channel mode

Under this mode, both the curve and data will be displayed at the same time, as shown in figure 11. In case of several channels need to be recorded, users can switch to the curve and data of other channels manually or automatically.

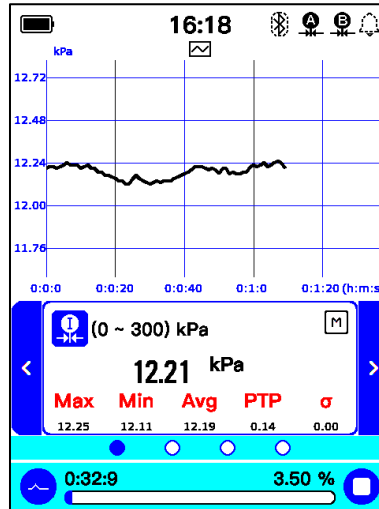

Figure 11 Single-channel mode

Click the data area to switch the channel mode. When the top right area shows **M**, it means manual switch at present. Click the left and right icon or the physical direction key to switch the channels. When the top right area shows **5S** or **30S**, it means automatic switch mode is activated, and the device will automatically switch to next channel every 5s or 30s. In this mode, it can also be switched to manual mode at any time.

6.1.2 Multi-channel list mode

Under this mode, there can be the curve or data of at most 3 channels to be displayed at one page, as shown in figure 12. The channel can fit with the sizes and when logging more than 3 channels, there will be the icon for page switching, click the icon or the physical direction key to switch between pages.

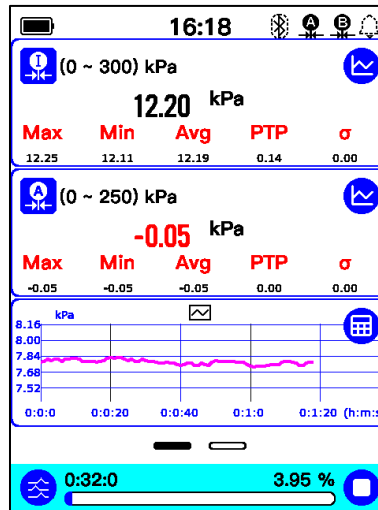



Figure 12 Multi-channel list mode

Click the icon  at top right to switch to curve display. And click the icon  to switch back to data display. When

using curve, click the curve area to switch the curve mode.

6.2 Channel data

It includes the real time measured value, maximum, minimum, average, peak to peak value and standard deviation.

6.3 Channel curve

The Y axis of the channel curve can adapt to the scale based on current value. The curve supports following mode (1x, 2x and 4x) and eye pattern mode. Click the curve area to switch the mode of curve.

6.3.1 Following Mode

The curve will always show the latest data. When the display is fully filled with the curve, the X axis will move forward by half, and new data will be continually recorded on the curve. For 1x following, every recorded point will be added for one point on the curve; For 2x following, every two recorded points will be added for one point on the curve; and for 4x following, every four recorded points will be added for one point on the curve.

6.3.2 Eye pattern mode

The curve will always show the samples of all recorded data. When the display is fully filled with the curve, the X axis will be compressed to half.

6.4 Save the data

When the data logging is complete, the device will automatically display the record save interface, and the record name, operator, time & date information need to be entered. Then the logging will be saved as a file. For the previous saved data, it can be found in the “Data logging management” menu or go to the “Data management” function.



7. Applications

7.1 Differential pressure module

The ADT260Ex provides the function of combining two pressure modules (any 2 of the internal pressure module, external pressure module A and B) into a differential pressure module. This provides a convenient differential pressure(DP) test solution in a high static pressure environment. The set parameters of the DP module are shown in the table below.

Table 12 Pressure delta setting

Project	Effective value	Description
Enable	Enable/ disable	Enable or disable the differential pressure module. When the differential pressure module is enabled, the differential pressure module channels will be displayed in the related functions channel list.
Resolution	4/5/6	The resolution of differential pressure
Range	Numbers	Differential module measuring range
Calculate type	The difference between two modules	The composition method of differential pressure module
Real time data	----- or Real time differential pressure value	The real-time differential pressure value is displayed only when the differential pressure module is enabled, and the pressure modules are all online. Otherwise, the real-time differential pressure value is displayed as -----

Zero offset	Zero offset generated by performing zeroing	Zero offset when performing differential pressure module zeroing
Pressure module A	S/N of the pressure module	
Pressure module B	S/N of the pressure module	
Zero		Perform zero to the differential pressure module, the zero offset will be saved and used for calculation
Cancel zero		Cancel the zero-offset created when performing the zero, reset the zero offset to 0

7.2 Units converter

The device provides unit converter for pressure units and temperature units, users can select multiple pressure units or temperature units for conversion. Click the unit converter icon on the main interface of the device to enter the unit converter. Click  icon on the right top to select and switch between different unit types. Click the unit under the value display to select and switch between different units.

7.3 Wiring help

The wiring help function in the device can help users to connect the wires correctly under various working conditions of the calibrator. It can be entered by clicking the "Wiring help" menu in each channel, or by clicking the "wiring help" icon in the main interface of the device.

7.4 Leak test

The device provides a pressure leak test function, which can perform self-checking on the seal of the device. Click on



the pressure module column to set the test parameters, see the table below:

Table 13 Leak test setting

Subject	Valid value	Description
Pressure type	GP/ AP	The pressure type being recorded, view detail according to device's module
Pressure unit	Pressure unit	Select corresponding pressure unit
Waiting time	Numbers	The pressurizing time of external module
Test time	Numbers	Total record time
Unit of the rate	Second/ minute	Displayed unit after calculation

7.4.1 Leak Test Performing

1. Connect to air circuit

- a. Connect the device to the air circuit;
- b. Click the start icon at the bottom of the screen, apply pressure to the leak test point;
- c. Start counting down the waiting time, and record the real-time pressure at the end of the waiting time as the initial pressure;
- d. Start the test, count down the test time, and start to calculate the real-time leakage, $\text{real-time leakage} = \text{initial pressure} - \text{real time pressure}$;
- e. Record the pressure at the end of the test time as the end pressure;
- f. The entire leak detection process ends, and the final leakage = $\text{initial pressure} - \text{end pressure}$;

2. The entire process will be displayed in stages in the leak curve at the bottom of the screen.

7.5 PSV test

The device provides function of PSV test, to test the safety pressure of the safety valves. Click the pressure module on the top, to set relevant parameters, see table below:

Table 14 PSV test setting

Subject	Valid value	Description
Pressure module	Internal pressure module, external module A or B	Select the pressure module
Test time	00:00:00 ~ 00:10:00	Set test time
Pressure unit	Different modules support different pressure units	Select corresponding pressure unit

7.5.1 PSV test performing

1. Connect air circuit
 - a. Connect the device to the air circuit;
 - b. Press the Start icon on the right of the screen to start performing, apply the pressure gradually to the safety valve;
 - c. Count down the test time and record the real-time pressure value and create the pressure curve, then record the maximum pressure during the process;
 - d. Count down complete, the entire leak test process finishes, save the data;
2. The entire process will be shown in the leak test curve at the bottom of the screen



7.6 Sensor library

To meet the needs of custom sensor types, the ADT260Ex provides a sensor library function. In the sensor library function, users can define new sensor types according to their needs and set relevant parameters in the sensor. The sensor library supports a total of four types of custom sensors: ITS-90, CVD, RTD and TC.



Additel Corporation

2900 Saturn Street #B

Brea, CA 92821 USA

Phone: 714-998-6899

Email: service@additel.com

website: www.additel.com